

# Quick Guide to Precision Measuring Instruments





## CONTENTS

Meaning of Symbols	4
Conformance to CE Marking	5
Quality Control	6
Micrometers	8
Micrometer Heads	14
Internal Micrometers	18
Calipers	20
Height Gages	23
Gauge Blocks	25
Dial Gages and Digital Indicators	26
Linear Gages	30
Laser Scan Micrometers	32
Linear Scales	34
Profile Projectors	37
Microscopes	38
Vision Measuring Machines	40
Surftest (Surface Roughness Testers)	42
Contracer (Contour Measuring Instruments)	44
Roundtest (Roundform Measuring Instruments)	46
Hardness Testing Machines	48
Coordinate Measuring Machines	50

# Meaning of Symbols



## ABSOLUTE Linear Encoder

Mitutoyo's technology has realized the absolute position method (absolute method). With this method, you do not have to reset the system to zero after turning it off and then turning it on. The position information recorded on the scale is read every time. The following three types of absolute encoders are available: electrostatic capacitance model, electromagnetic induction model and model combining the electrostatic capacitance and optical methods. These encoders are widely used in a variety of measuring instruments as the length measuring system that can generate highly reliable measurement data.

### Advantages:

1. No count error occurs even if you move the slider or spindle extremely rapidly.
2. You do not have to reset the system to zero when turning on the system after turning it off<sup>\*1</sup>.
3. As this type of encoder can drive with less power than the incremental encoder, the battery life is prolonged to about 3.5 years (continuous operation of 20,000 hours)<sup>\*2</sup> under normal use.

\*1: Unless the battery is removed.

\*2: In the case of the ABSOLUTE Digimatic caliper. (electrostatic capacitance model)



## IP Codes

These are codes that indicate the degree of protection provided (by an enclosure) for the electrical function of a product against the ingress of foreign bodies, dust and water as defined in IEC standards (IEC 60529: 2001) and JIS C 0920: 2003. [IEC: International Electrotechnical Commission]

First characteristic numeral	Degrees of protection against solid foreign objects	
	Brief description	Definition
0	Unprotected	—
1	Protected against solid foreign objects of $\geq 50\text{mm}$ and greater	A $\geq 50\text{mm}$ object probe shall not fully penetrate enclosure*
2	Protected against solid foreign objects of $\geq 12.5\text{mm}$ and greater	A $\geq 12.5\text{mm}$ object probe shall not fully penetrate enclosure*
3	Protected against solid foreign objects of $\geq 2.5\text{mm}$ and greater	A $\geq 2.5\text{mm}$ object probe shall not fully penetrate enclosure*
4	Protected against solid foreign objects of $\geq 1.0\text{mm}$ and greater	A $\geq 1.0\text{mm}$ object probe shall not fully penetrate enclosure*
5	Protected against dust	Ingress of dust is not totally prevented, but dust that does penetrate must not interfere with satisfactory operation of the apparatus or impair safety.
6	Dust-proof	No ingress of dust allowed.
7	—	—
8	—	—

\*: For details of the test conditions used in evaluating each degree of protection, please refer to the original standard.

Second characteristic numeral	Degrees of protection against water	
	Brief description	Definition
0	Unprotected	—
1	Protected against vertical water drops	Vertically falling water drops shall have no harmful effects.
2	Protected against vertical water drops within a tilt angle of 15 degrees	Vertically falling water drops shall have no harmful effects when the enclosure is tilted at any angle up to 15° on either side of the vertical.
3	Protected against spraying water	Water sprayed at an angle up to 60° either side of the vertical shall have no harmful effects.
4	Protected against splashing water	Water splashed against the enclosure from any direction shall have no harmful effects.
5	Protected against water jets	Water projected in jets against the enclosure from any direction shall have no harmful effects.
6	Protected against powerful water jets	Water projected in powerful jets against the enclosure from any direction shall have no harmful effects.
7	Protection against water penetration	Ingress of water in quantities causing harmful effects shall not be possible when the enclosure is temporarily immersed in water under standardized conditions of pressure and time.
8	Protected against the effects of continuous immersion in water	Ingress of water in quantities causing harmful effects shall not be possible when the enclosure is continuously immersed in water under conditions which shall be agreed between manufacturer and user but which are more severe than for IPX7.

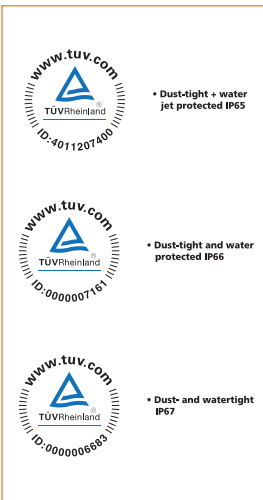

## Independent Confirmation of Compliance

IP65, IP66 and IP67 protection level ratings for applicable Mitutoyo products have been independently confirmed by the German accreditation organization, TÜV Rheinland.

# Conformance to CE Marking

In order to improve safety, each plant has programs to comply with the Machinery Directives, the EMC Directives, and the Low Voltage Directives. Compliance to CE marking is also satisfactory. CE stands for "Conformité Européenne". CE marking indicates that a product complies with the essential requirements of the relevant European health, safety and environmental protection legislation.

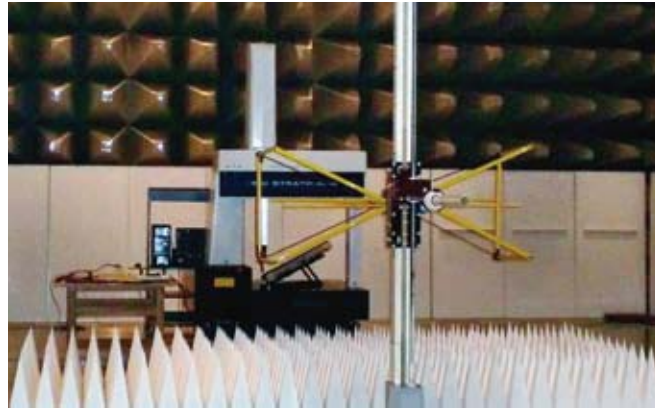

# Quality Control

## Quality control (QC)

A system for economically producing products or services of a quality that meets customer requirements.

## Process quality control

Activities to reduce variation in product output by a process and keep this variation low. Process improvement and standardization as well as technology accumulation are promoted through these activities.

## Statistical process control (SPC)

Process quality control through statistical methods.

## Population

A group of all items that have characteristics to be considered for improving and controlling processes and quality of product. A group which is treated based on samples is usually the population represented by the samples.

## Lot

Collection of product produced under the same conditions.

## Sample

An item of product (or items) taken out of the population to investigate its characteristics.

## Sample size

Number of product items in the sample.

## Bias

Value calculated by subtracting the true value from the mean of measured values when multiple measurements are performed.

## Dispersion

Variation in the values of a target characteristic in relation to the mean value. Standard deviation is usually used to represent the dispersion of values around the mean.

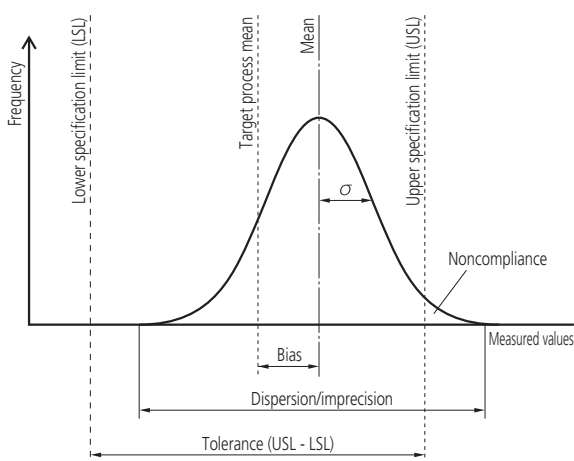

## Histogram

A diagram that divides the range between the maximum and the minimum measured values into several divisions and shows the number of values (appearance frequency) in each division in the form of a bar graph. This makes it easier to understand the rough average or the approximate extent of dispersion. A bell-shaped symmetric distribution is called the normal distribution and is much used in theoretical examples on account of its easily calculable characteristics. However, caution should be observed because many real processes do not conform to the normal distribution, and error will result if it is assumed that they do.

## Process capability

Process-specific performance demonstrated when the process is sufficiently standardized, any causes of malfunctions are eliminated, and the process is in a state of statistical control. The process capability is represented by mean  $\pm 3\sigma$  or  $6\sigma$  when the quality characteristic output from the process shows normal distribution.  $\sigma$  (sigma) indicates standard deviation.

## Process capability index (PCI or Cp)

A measure of how well the process can operate within the tolerance limits of the target characteristic. It should always be significantly greater than one. The index value is calculated by dividing the tolerance of a target characteristic by the process capability ( $6\sigma$ ). The value calculated by dividing the difference between the mean ( $\bar{X}$ ) and the standard value by  $3\sigma$  may be used to represent this index in cases of a unilateral tolerance. The process capability index assumes that a characteristic follows the normal distribution.

**Notes:** If a characteristic follows the normal distribution, 99.74% data is within the range  $\pm 3\sigma$  from the mean.

Bilateral tolerance

$$C_p = \frac{USL - LSL}{6\sigma}$$

USL: Upper specification limit  
LSL: Lower specification limit

Unilateral tolerance ... If only the upper limit is stipulated

$$C_p = \frac{USL - \bar{X}}{3\sigma}$$

Unilateral tolerance ... If only the lower limit is stipulated

$$C_p = \frac{\bar{X} - LSL}{3\sigma}$$

**Specific examples of a process capability index (Cp) (bilateral tolerance)**

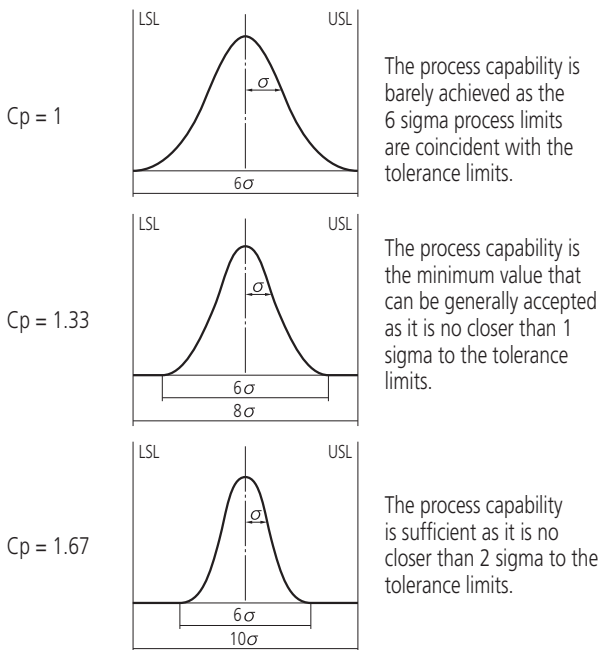

Note that Cp only represents the relationship between the tolerance limits and the process dispersion and does not consider the position of the process mean.

**Notes:** A process capability index that takes the difference between the process mean from the target process mean into consideration is generally called Cpk, which is the upper tolerance (USL minus the mean) divided by 3σ (half of process capability) or the lower tolerance (the mean value minus LSL) divided by 3σ, whichever is smaller.

**Control chart**

Used to control the process by separating the process variation into that due to chance causes and that due to a malfunction. The control chart consists of one center line (CL) and the control limit lines rationally determined above and below it (UCL and LCL). It can be said that the process is in a state of statistical control if all points are within the upper and lower control limit lines without notable trends when the characteristic values that represent the process output are plotted. The control chart is a useful tool for controlling process output, and therefore quality.

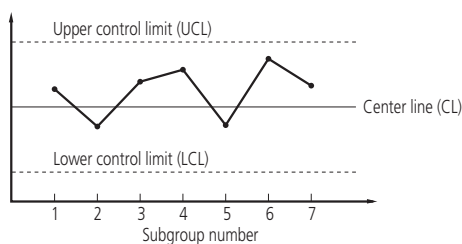

**Chance causes**

These causes of variation are of relatively low importance. Chance causes are technologically or economically impossible to eliminate even if they can be identified.

**X̄-R control chart**

A control chart used for process control that provides the most information on the process. The X̄-R control chart consists of the X̄ control chart that uses the mean of each subgroup for control to monitor abnormal bias of the process mean and the R control chart that uses the range for control to monitor abnormal variation. Usually, both charts are used together.

**How to read the control chart**

Typical trends of successive point position in the control chart that are considered undesirable are shown below. These trends are taken to mean that a 'special cause' is affecting the process output and that action from the process operator is required to remedy the situation. These determination rules only provide a guideline. Take the process-specific variation into consideration when actually making determination rules. Assuming that the upper and the lower control limits are 3σ away from the center line, divide the control chart into six regions at intervals of 1σ to apply the following rules. These rules are applicable to the X control chart and the X̄ control chart. Note that these 'trend rules for action' were formulated assuming a normal distribution. Rules can be formulated to suit any other distribution.

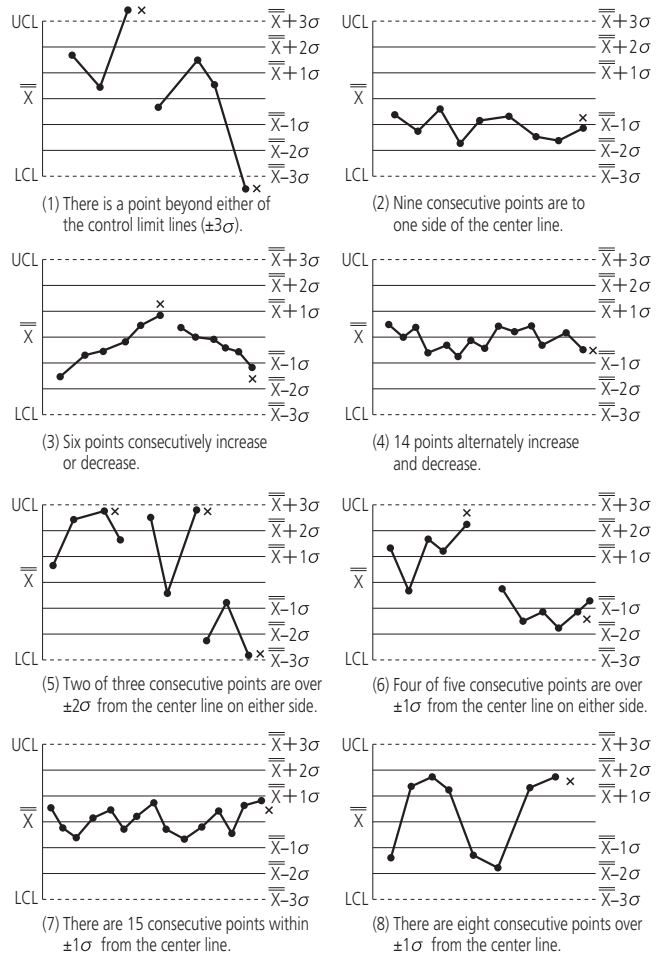

**Note:** This part of 'Quick Guide to Precision Measuring Instruments' (pages 6 and 7) has been written by Mitutoyo based on its own interpretation of the JIS Quality Control Handbook published by the Japanese Standards Association.

**References**

- JIS Quality Control Handbook (Japanese Standards Association)

- Z 8101: 1981
- Z 8101-1: 1999
- Z 8101-2: 1999
- Z 9020: 1999
- Z 9021: 1998

# Micrometers

## ■ Nomenclature

### Standard Analogue Outside Micrometer

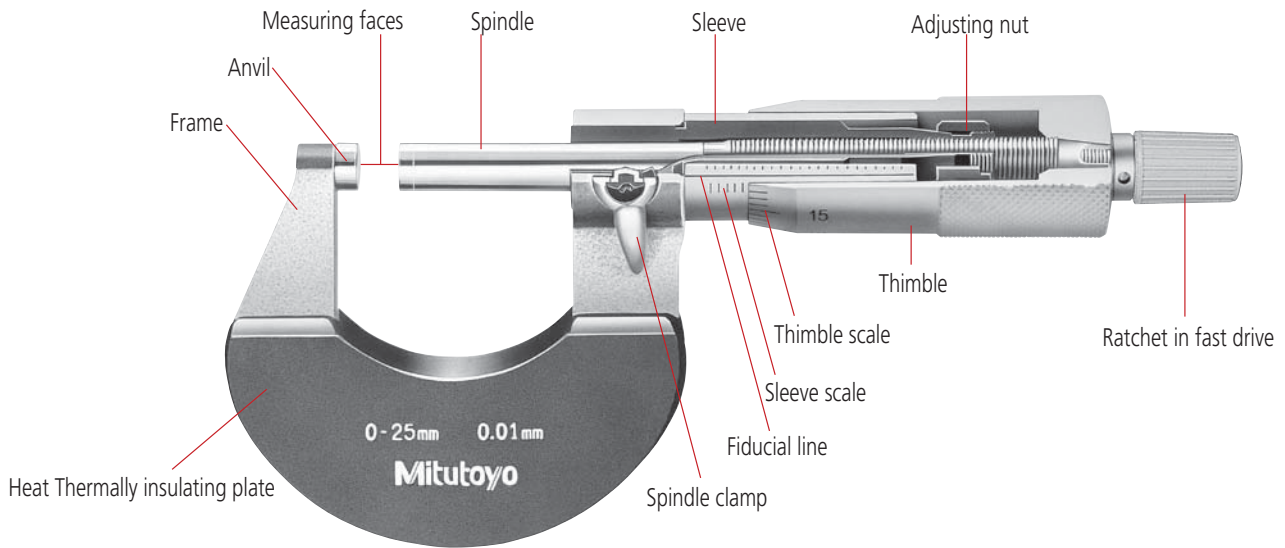

### Digimatic Outside Micrometer





■ Special Purpose Micrometer Applications

Blade micrometer

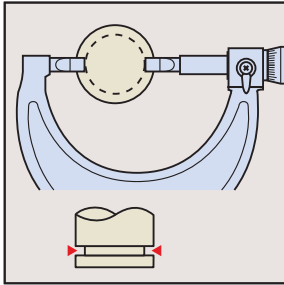

For diameter inside narrow groove measurement

Inside micrometer, caliper type

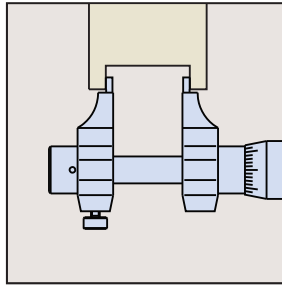

For small internal diameter, and groove width measurement

Spline micrometer

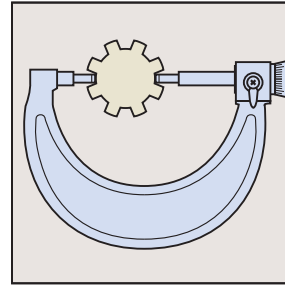

For splined shaft diameter measurement

Tube micrometer

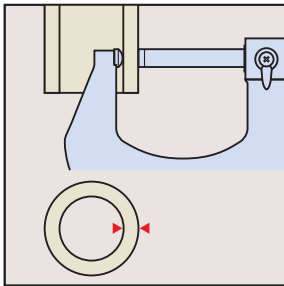

For pipe thickness measurement

Point micrometer

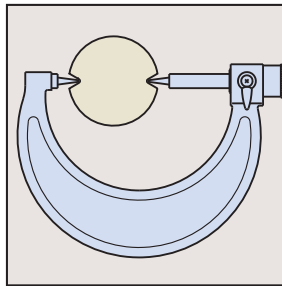

For root diameter measurement

Screw thread micrometer

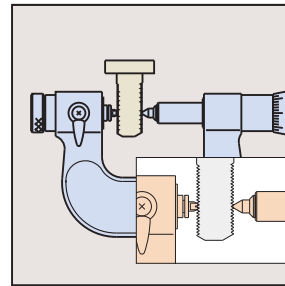

For effective thread diameter measurement

Disc type outside micrometer

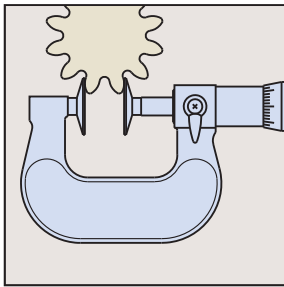

For root tangent measurement on spur gears and helical gears.

Ball tooth thickness micrometer

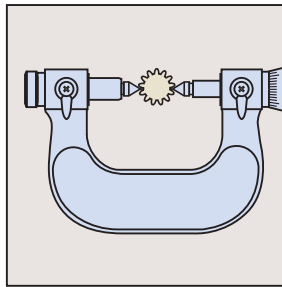

Measurement of gear over-pin diameter

V-anvil micrometer

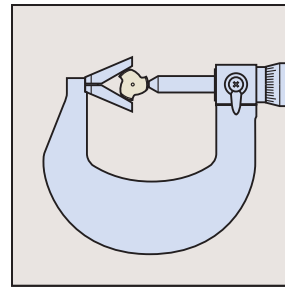

For measurement of 3- or 5-flute cutting tools

# Micrometers

## How to Read the Scale

### Micrometer with standard scale (graduation: 0.01mm)

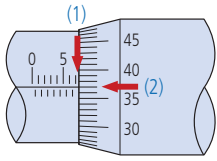

(1) Sleeve scale reading 7. mm  
 (2) Thimble scale reading + 0.37mm  
 Micrometer reading 7.37mm

Note) 0.37 mm (2) is read at the position where the sleeve fiducial line is aligned to the thimble graduations.

The thimble scale can be read directly to 0.01mm, as shown above, but may also be estimated to 0.001mm when the lines are nearly coincident because the line thickness is 1/5 of the spacing between them.

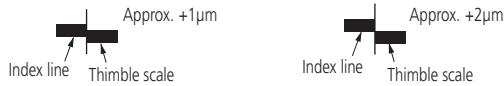

### Micrometer with vernier scale (graduation: 0.001mm)

The vernier scale provided above the sleeve index line enables direct readings to be made to within 0.001mm.

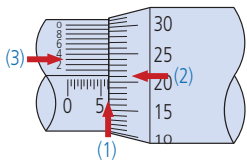

(1) Sleeve scale reading 6. mm  
 (2) Thimble scale reading .21mm  
 (3) Reading from the vernier scale marking and thimble graduation line + .003mm  
 Micrometer reading 6.213mm

Note) 0.21 mm (2) is read at the position where the index line is between two graduations (21 and 22 in this case). 0.003 mm (3) is read at the position where one of the vernier graduations aligns with one of the thimble graduations.

### Micrometer with mechanical-digit display (digital step: 0.001mm)

Third decimal place on vernier scale (0.001 mm units)

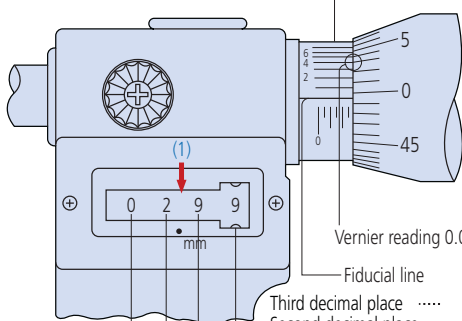

Vernier reading 0.004mm (2)

Fiducial line  
 Third decimal place ..... .004mm (2)  
 Second decimal place ..... .09 mm  
 First decimal place ..... .9 mm (1)  
 Millimetres ..... 2. mm  
 + Tens of mm ..... 00. mm  
 Counter reading 2.994mm

Note) 0.004 mm (2) is read at the position where a vernier graduation line corresponds with one of the thimble graduation lines.

## Measuring Force Limiting Device

	Audible in operation	One-handed operation	Remarks
Ratchet stop	Yes	Unsuitable	Audible clicking operation causes micro-shocks
Friction thimble (F type)	No	Suitable	Smooth operation without shock or sound
Ratchet thimble (T type)	Yes	Suitable	Audible operation provides confirmation of constant measuring force
Ratchet thimble	Yes	Suitable	Audible operation provides confirmation of constant measuring force

## Measuring Face Detail

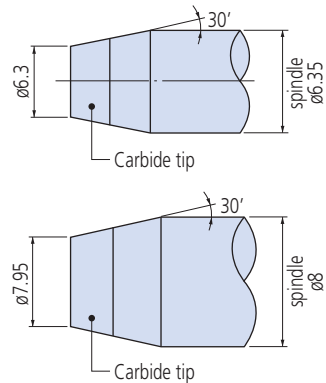

These drawings above are for illustration only and are not to scale

### Micrometer Expansion due to Holding Frame with the Bare Hand

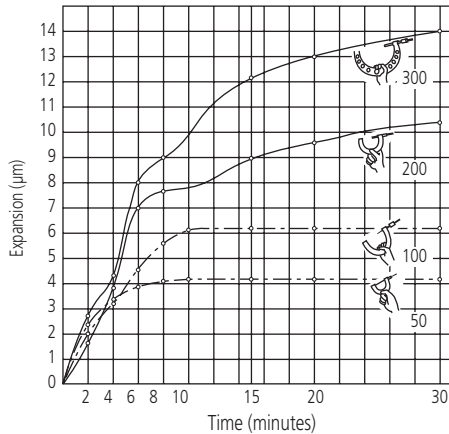

The above graph shows micrometer frame expansion due to heat transfer from hand to frame when the frame is held in the bare hand which, as can be seen, may result in a significant measurement error due to temperature-induced expansion. If the micrometer must be held by hand during measurement then try to minimize contact time. A heat insulator will reduce this effect considerably if fitted, or gloves may be worn. (Note that the above graph shows typical effects, and is not guaranteed).

### Length Standard Expansion with Change of Temperature (for 200mm bar initially at 20°C)

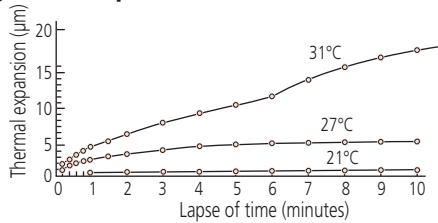

The above experimental graph shows how a particular micrometer standard expanded with time as people whose hand temperatures were different (as shown) held the end of it at a room temperature of 20°C. This graph shows that it is important not to set a micrometer while directly holding the micrometer standard but to make adjustments only while wearing gloves or lightly supporting the length standard by its heat insulators. When performing a measurement, note also that it takes time until the expanded micrometer standard returns to the original length. (Note that the graph values are not guaranteed values but experimental values.)

### Difference in Thermal Expansion between Micrometer and Length Standard

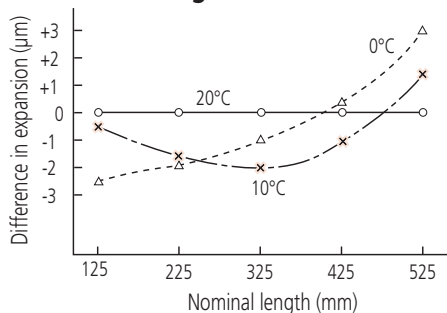

In the above experiment, after the micrometer and its standard were left at a room temperature of 20°C for about 24 hours for temperature stabilization, the start point was adjusted using the micrometer standard. Then, the micrometer with its standard were left at the temperatures of 0°C and 10°C for about the same period of time, and the start point was tested for shift. The above graph shows the results for each of the sizes from 125 through 525 mm at each temperature. This graph shows that both the micrometer and its standard must be left at the same location for at least several hours before adjusting the start point. (Note that the graph values are not guaranteed values but experimental values.)

### Effect of Changing Support Method and Orientation (Unit: µm)

Changing the support method and/or orientation of a micrometer after zero setting affects subsequent measuring results. The tables below highlight the measurement errors to be expected in three other cases after micrometers are zero-set in the 'Supported at the bottom and center' case. These actual results show that it is best to set and measure using the same orientation and support method.

Supporting method	Supported at the bottom and center	Supported only at the center
Attitude		
Maximum measuring length (mm)		
325	0	-5.5
425	0	-2.5
525	0	-5.5
625	0	-11.0
725	0	-9.5
825	0	-18.0
925	0	-22.5
1025	0	-26.0

Supporting method	Supported at the center in a lateral orientation.	Supported by hand downward.
Attitude		
Maximum measuring length (mm)		
325	+1.5	-4.5
425	+2.0	-10.5
525	-4.5	-10.0
625	0	-5.5
725	-9.5	-19.0
825	-5.0	-35.0
925	-14.0	-27.0
1025	-5.0	-40.0

### Abbe's Principle

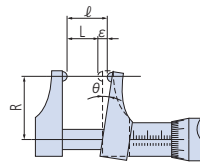

Abbe's principle states that "maximum accuracy is obtained when the scale and the measurement axes are common".

This is because any variation in the relative angle ( $\theta$ ) of the moving measuring jaw on an instrument, such as a caliper jaw micrometer, causes displacement that is not measured on the instrument's scale and this is an Abbe error ( $\epsilon = l - L$  in the diagram). Spindle straightness error, play in the spindle guide or variation of measuring force can all cause ( $\theta$ ) to vary and the error increases with R.

### Hooke's Law

Hooke's law states that strain in an elastic material is proportional to the stress causing that strain, providing the strain remains within the elastic limit for that material.

### Hertz's Formulae

Hertz's formulae give the apparent reduction in diameter of spheres and cylinders due to elastic compression when measured between plane surfaces. These formulae are useful for determining the deformation of a workpiece caused by the measuring force in point and line contact situations.

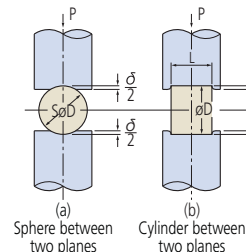

Assuming that the material is steel and units are as follows:  
 Modulus of elasticity:  $E = 205 \text{ GPa}$   
 Amount of deformation:  $\delta$  ( $\mu\text{m}$ )  
 Diameter of sphere or cylinder:  $D$  (mm)  
 Length of cylinder:  $L$  (mm)  
 Measuring force:  $P$  (N)  
 a) Apparent reduction in diameter of sphere  
 $\delta_1 = 0.82 \sqrt{P/D}$   
 b) Apparent reduction in diameter of cylinder  
 $\delta_2 = 0.094 \cdot PL \sqrt{1/D}$

# Micrometers

## Major measurement errors of the screw micrometer

Error cause	Maximum possible error	Precautions for eliminating errors	Error that might not be eliminated even with precautions
Micrometer feed error	3µm	1. Correct the micrometer before use.	±1µm
Anvil angle error	±5µm assuming the error of a half angle is 15 minutes	1. Measure the angle error and correct the micrometer. 2. Adjust the micrometer using the same thread gage as the workpiece.	±3µm expected measurement error of half angle
Misaligned contact points	+10µm		+3µm
Influence of measuring force	±10µm	1. Use a micrometer with a low measuring force if possible. 2. Always use the ratchet stop. 3. Adjust the micrometer using a thread gage with the same pitch.	+3µm
Angle error of thread gage	±10µm	1. Perform correction calculation (angle). 2. Correct the length error. 3. Adjust the micrometer using the same thread gage as the workpiece.	+3µm
Length error of thread gage	±(3 + $\frac{1}{25}$ )µm	1. Perform correction calculation. 2. Adjust the micrometer using the same thread gage as the workpiece.	±1µm
Workpiece thread angle error	JIS 2 grade error of half angle ±229 minutes -91µm +71µm	1. Minimize the angle error as much as possible. 2. Measure the angle error and perform correction calculation. 3. Use the three-wire method for a large angle error.	±8µm assuming the error of half angle is ±23 minutes
Cumulative error	(±117+40)µm		+26µm -12µm

## Screw pitch diameter measurement

### Three-wire method

The screw pitch diameter can be measured with the three-wire method as shown in the figure.

Calculate the pitch diameter (E) with equations (1) and (2).

Metric thread or unified screw (60°)

$$E = M - 3d + 0.866025P \quad \dots\dots(1)$$

Whitworth thread (55°)

$$E = M - 3.16568d + 0.960491P \quad \dots\dots(2)$$

d = Wire diameter

E = Screw pitch diameter

M = Micrometer reading including three wires

P = Screw pitch

(Convert inches to millimeters for unified screws.)

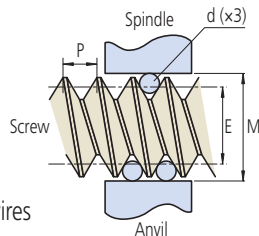

Thread type	Optimal wire size at D
Metric thread or unified screw (60°)	0.577P
Whitworth thread (55°)	0.564P

## Major measurement errors of the three-wire method

Error cause	Precautions for eliminating errors	Possible error	Error that might not be eliminated even with precautions
Pitch error (workpiece)	1. Correct the pitch error ( $\delta p = \delta E$ ) 2. Measure several points and adopt their average. 3. Reduce single pitch errors.	±18µm assuming that the pitch error is 0.02 mm.	±3µm
Error of half angle (workpiece)	1. Use the optimal wire diameter. 2. No correction is needed.	±0.3µm	±0.3µm
Due to anvil difference	1. Use the optimal wire diameter. 2. Use the wire which has a diameter close to the average at the one wire side.	±8µm	±1µm
Wire diameter error	1. Use the predetermined measuring force appropriate for the pitch. 2. Use the predetermined width of measurement edge. 3. Use a stable measuring force.	-3µm	-1µm
Cumulative error		In the worst case +20µm -35µm	When measured carefully +3µm -5µm

### One-wire method

The pitch diameter of odd-fluted tap can be measured using the V-anvil micrometer with the one-wire method. Obtain the measured value (M<sub>1</sub>) and calculate M with equation (3) or (4).

M<sub>1</sub> = Micrometer reading during one-wire measurement

D = Odd-fluted tap diameter

$$\text{Tap with three flutes : } M = 3M_1 - 2D \quad \dots\dots(3)$$

$$\text{Tap with five flutes : } M = 2.2360M_1 - 1.23606D \quad \dots\dots(4)$$

Then, assign the calculated M to equation (1) or (2) to calculate the pitch diameter (E).

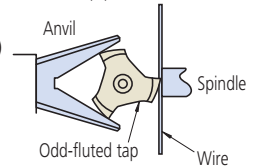

## Root tangent length

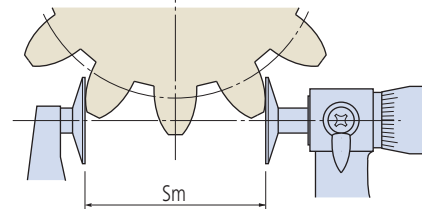

Formula for calculating a root tangent length (Sm):

$$Sm = m \cos \alpha_0 \{ \pi (Zm - 0.5) + Z \operatorname{inv} \alpha_0 \} + 2Xm \sin \alpha_0$$

Formula for calculating the number of teeth within the root tangent length (Zm):

$$Zm' = Z \cdot K(f) + 0.5 \quad (Zm \text{ is the integer closest to } Zm')$$

where,  $K(f) = \frac{1}{\pi} \{ \sec \alpha_0 \sqrt{(1 + 2f)^2 - \cos^2 \alpha_0} - \operatorname{inv} \alpha_0 - 2f \tan \alpha_0 \}$

$$\text{and, } f = \frac{X}{Z}$$

$$\operatorname{inv} 20^\circ \cong 0.014904$$

$$\operatorname{inv} 14.5^\circ \cong 0.0055448$$

- m: Module
- α<sub>0</sub>: Pressure angle
- Z: Number of teeth
- X: Addendum modification coefficient
- Sm: Root tangent length
- Zm: Number of teeth within the root tangent length

## Gear measurement

Over-pin method

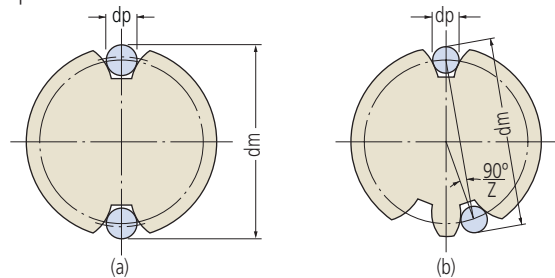

For a gear with an even number of teeth:

$$dm = dp + \frac{dg}{\cos \theta} = dp + \frac{Z \cdot m \cdot \cos \alpha_0}{\cos \theta}$$

For a gear with an odd number of teeth:

$$dm = dp + \frac{dg}{\cos \theta} \cdot \cos \left( \frac{90^\circ}{Z} \right) = dp + \frac{Z \cdot m \cdot \cos \alpha_0}{\cos \theta} \cdot \cos \left( \frac{90^\circ}{Z} \right)$$

however,

$$\operatorname{inv} \theta = \frac{dp}{dg} - \frac{X}{Z} = \frac{dp}{Z \cdot m \cdot \cos \alpha_0} - \left( \frac{\pi}{2Z} - \operatorname{inv} \alpha_0 \right) + \frac{2 \tan \alpha_0}{Z} \cdot X$$

Obtain θ (invθ) from the involute function table.

- Z: Number of teeth
- α<sub>0</sub>: Pressure angle teeth
- m: Module
- X: Addendum modification coefficient

### ■ Testing Parallelism of Micrometer Measuring Faces

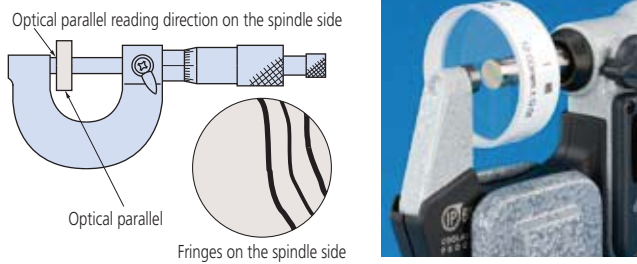

Parallelism can be estimated using an optical parallel held between the faces. Firstly, bring the parallel to the anvil measuring face. Then close the spindle on the parallel using normal measuring force and count the number of red interference fringes seen on the measuring face of the spindle in white light. Each fringe represents a half wavelength difference in height ( $0.32\mu\text{m}$  for red fringes). In the above figure a parallelism of approximately  $1\mu\text{m}$  is obtained from  $0.32\mu\text{m} \times 3 = 0.96\mu\text{m}$ .

### ■ Testing Flatness of Micrometer Measuring Faces

Flatness can be estimated using an optical flat (or parallel) held against a face. Count the number of red interference fringes seen on the measuring face in white light. Each fringe represents a half wavelength difference in height ( $0.32\mu\text{m}$  for red).

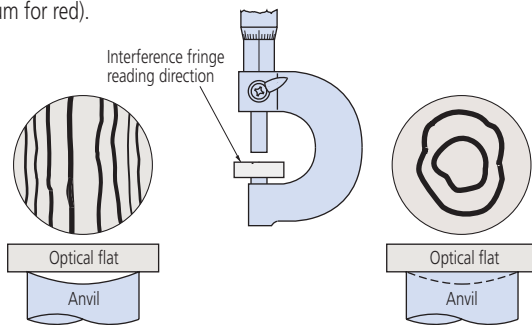

Measuring face is curved by approximately  $1.3\mu\text{m}$ . ( $0.32\mu\text{m} \times 4$  paired red fringes.)

Measuring face is concave (or convex) approximately  $0.6\mu\text{m}$  deep. ( $0.32\mu\text{m} \times 2$  continuous fringes)

### ■ General notes on using the micrometer

- Carefully check the type, measuring range, accuracy, and other specifications to select the appropriate model for your application.
- Leave the micrometer and workpiece at room temperature long enough for their temperatures to equalize before making a measurement.
- Look directly at the fiducial line when taking a reading against the thimble graduations.  
If the graduation lines are viewed from an angle, the correct alignment position of the lines cannot be read due to parallax error.

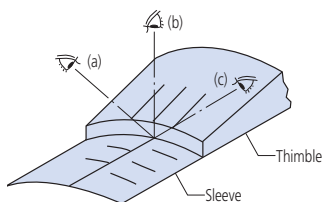

(a) From above the index line



(b) Looking directly at the index line



(c) From below the index line

- Wipe off the measuring faces of both the anvil and spindle with lint-free paper set the start (zero) point before measuring.



- Wipe away any dust, chips and other debris from the circumference and measuring face of the spindle as part of daily maintenance. In addition, sufficiently wipe off any stains and fingerprints on each part with dry cloth.
- Use the constant-force device correctly so that measurements are performed with the correct measuring force.
- When attaching the micrometer onto a micrometer stand, the stand should clamp the center of the micrometer frame. Do not clamp it too tightly.

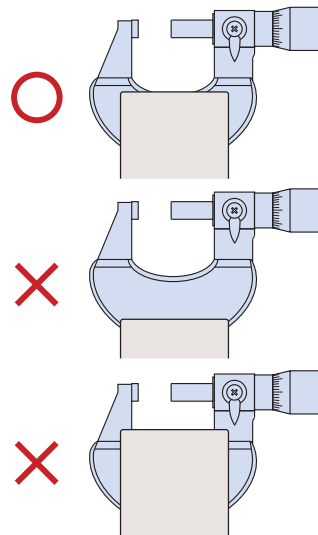

- Be careful not to drop or bump the micrometer on anything. Do not rotate the micrometer thimble using excessive force. If you believe a micrometer may have been damaged due to accidental mishandling, ensure that it is inspected for accuracy before further use.
- After a long storage period or when there is no protective oil film visible, lightly apply anti-corrosion oil to the micrometer by wiping with a cloth soaked in it.
- Notes on storage:  
Avoid storing the micrometer in direct sunlight.  
Store the micrometer in a ventilated place with low humidity.  
Store the micrometer in a place with little dust.  
Store the micrometer in a case or other container, which should not be kept on the floor.  
When storing the micrometer, always leave a gap of 0.1 to 1 mm between the measuring faces.  
Do not store the micrometer in a clamped state.

# Micrometer Heads

## Key Factors in Selection

Key factors in selecting a micrometer head are the measuring range, spindle face, stem, graduations, thimble diameter, etc.

### Stem

Plain stem

Stem locknut type

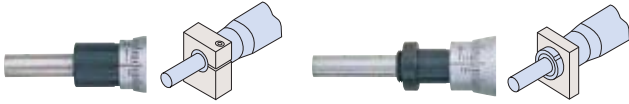

- The stem used to mount a micrometer head is classified as a "plain type" or "clamp nut type" as illustrated above. The stem diameter is manufactured to a nominal Metric or Imperial size with an h6 tolerance.
- The clamp nut stem allows fast and secure clamping of the micrometer head. The plain stem has the advantage of wider application and slight positional adjustment in the axial direction on final installation, although it does require a split-fixture clamping arrangement or adhesive fixing.
- General-purpose mounting fixtures are available as optional accessories.

### Measuring Face



Flat face



Spherical face



Anti-rotation device

- A flat measuring face is often specified where a micrometer head is used in measurement applications.
- When a micrometer head is used as a feed device, a spherical face can minimize errors due to misalignment (Figure A). Alternatively, a flat face on the spindle can bear against a sphere, such as a carbide ball (Figure B).
- A non-rotating spindle type micrometer head or one fitted with an anti-rotation device on the spindle (Figure C) can be used if a twisting action on the workpiece must be avoided.
- If a micrometer head is used as a stop then a flat face both on the spindle and the face it contacts provides durability.

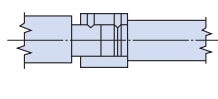
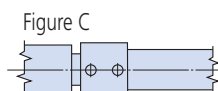
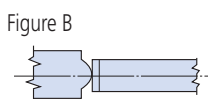
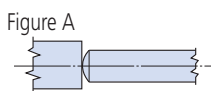

### Non-Rotating Spindle

- A non-rotating spindle type head does not exert a twisting action on a workpiece, which may be an important factor in some applications.

### Spindle Thread Pitch

- The standard type head has 0.5mm pitch.
- 1mm-pitch type: quicker to set than standard type and avoids the possibility of a 0.5mm reading error. Excellent load-bearing characteristics due to larger screw thread.
- 0.25mm or 0.1mm-pitch type  
This type is the best for fine-feed or fine-positioning applications.

### Constant-force Device

- A micrometer head fitted with a constant-force device (ratchet or friction thimble) is recommended for measurement applications.
- If using a micrometer head as a stop, or where saving space is a priority, a head without a ratchet is probably the best choice.



Micrometer head with constant-force device



Micrometer head without constant-force device (no ratchet)

### Spindle Lock

- If a micrometer head is used as a stop it is desirable to use a head fitted with a spindle lock so that the setting will not change even under repeated shock loading.



### Measuring Range (Stroke)

- When choosing a measuring range for a micrometer head, allow an adequate margin in consideration of the expected measurement stroke. Six stroke ranges, 5 to 50mm, are available for standard micrometer heads.
- Even if an expected stroke is small, such as 2mm to 3mm, it will be cost effective to choose a 25mm-stroke model as long as there is enough space for installation.
- If a long stroke of over 50mm is required, the concurrent use of a gauge block can extend the effective measuring range. (Figure D)

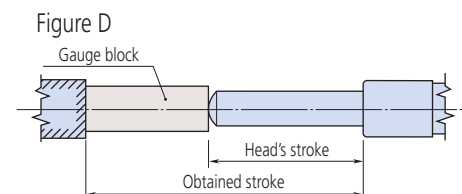

- In this guide, the range (or stroke end) of the thimble is indicated by a dashed line. For stroke ends, consider the thimble as moving to the position indicated by the line when designing the jig.

### Ultra-fine Feed Applications

- Dedicated micrometer heads are available for manipulator applications, etc., which require ultra-fine feed or adjustment of spindle.

### Thimble Diameter

- The diameter of a thimble greatly affects its usability and the "fineness" of positioning. A small-diameter thimble allows quick positioning whereas a large-diameter thimble allows fine positioning and easy reading of the graduations. Some models combine the advantages of both features by mounting a coarse-feed thimble (speeder) on the large-diameter thimble.



### Graduation Styles

- Care is needed when taking a reading from a mechanical micrometer head, especially if the user is unfamiliar with the model.
- The "normal graduation" style, identical to that of an outside micrometer, is the standard. For this style the reading increases as the spindle retracts into the body.
- On the contrary, in the "reverse graduation" style the reading increases as the spindle advances out of the body.
- The "bidirectional graduation" style is intended to facilitate measurement in either direction by using black numerals for normal, and red numerals for reverse, operation.
- Micrometer heads with a mechanical or electronic digital display, which allow direct reading of a measurement value, are also available. These types are free from misreading errors. A further advantage is that the electronic digital display type can enable computer-based storage and statistical processing of measurement data.

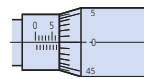

Normal graduation style

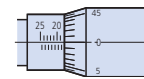

Reverse graduation style

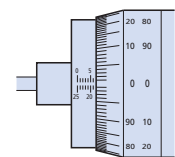

Bidirectional graduation style

### Guidelines for Self-made Fixtures

A micrometer head should be mounted by the stem in an accurately machined hole using a clamping method that does not exert excessive force on the stem. There are three common mounting methods as shown below. Method 3 is not recommended. Adopt methods (1) or (2) wherever possible.

(Unit: mm)

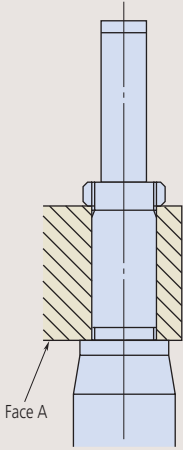
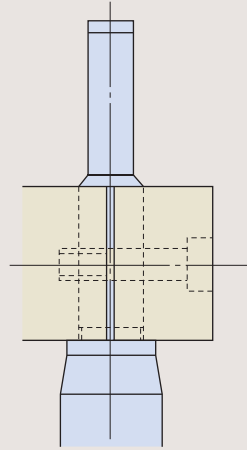
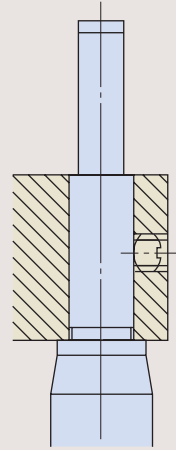
Mounting method	(1) Clamp nut				(2) Split-body clamp				(3) Setscrew clamp			
	Points to keep in mind											
Stem diameter	ø9.5	ø10	ø12	ø18	ø9.5	ø10	ø12	ø18	ø9.5	ø10	ø12	ø18
Mounting hole fitting tolerance	G7 +0.005 to +0.020		G7 +0.006 to +0.024		G7 +0.005 to +0.020		G7 +0.006 to +0.024		H5 0 to +0.006		H5 0 to +0.008	
Precautions	Care should be taken to make Face A square to the mounting hole. The stem can be clamped without any problem at squareness within 0.16/6.5.				Remove burrs generated on the wall of the mounting hole by the slitting operation.				M3x0.5 or M4x0.7 is an appropriate size for the setscrew. Use a brass plug under setscrew (if thickness of fixture allows) to avoid damaging stem.			

# Micrometer Heads

## ■ Maximum Loading Capacity on Micrometer Heads

The maximum loading capacity of a micrometer head depends mainly on the method of mounting and whether the loading is static or dynamic (used as a stop, for example). Therefore the maximum loading capacity of each model cannot be definitively specified. The loading limits recommended by Mitutoyo (at less than 100,000 revolutions if used for measuring within the guaranteed accuracy range) and the results of static load tests using a small micrometer head are given below.

### 1. Recommended maximum loading limit

		Maximum loading limit
Standard type	(spindle pitch: 0.5mm)	Up to approx. 4kgf *
	Spindle pitch: 0.1mm/0.25mm	Up to approx. 2kgf
High-functionality type	Spindle pitch: 0.5mm	Up to approx. 4kgf
	Spindle pitch: 1.0mm	Up to approx. 6kgf
	Non-rotating spindle	Up to approx. 2kgf
	MHF micro-fine feed type (with a differential mechanism)	Up to approx. 2kgf

\* Up to approx. 2kgf only for MHT

### 2. Static load test for micrometer heads (using MHS for this test)

(1) Clamp nut

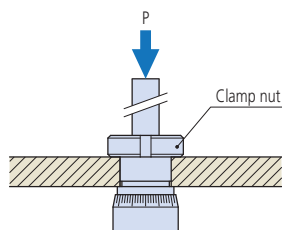

(2) Split-body clamp

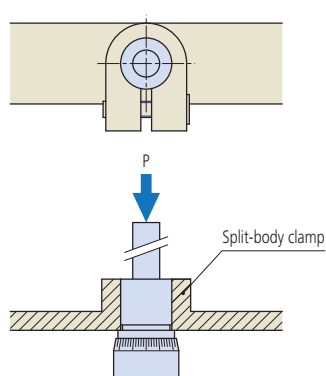

(3) Setscrew clamp

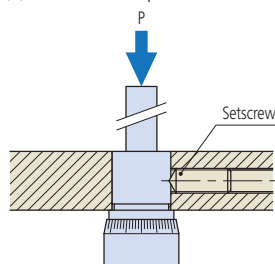

#### Test method

Micrometer heads were set up as shown and the force at which the head was damaged or pushed out of the fixture when a static load was applied, in direction P, was measured. (In the tests no account was taken of the guaranteed accuracy range.)

Mounting method	Damaging / dislodging load*
(1) Clamp nut	Damage to the main unit will occur at 8.63 to 9.8kN (880 to 1000kgf).
(2) Split-body clamp	The main unit will be pushed out of the fixture at 0.69 to 0.98kN (70 to 100kgf).
(3) Setscrew clamp	Damage to the setscrew will occur at 0.69 to 1.08kN (70 to 110kgf).

\* These load values should only be used as an approximate guide.



## ■ Custom-built Products (Product Example Introductions)

Micrometer heads have applications in many fields of science and industry and Mitutoyo offers a wide range of standard models to meet customers' needs. However, in those cases where the standard product is not suitable, Mitutoyo can custom build a head incorporating features better suited to your special application. Please feel free to contact Mitutoyo about the possibilities - even if only one custom-manufactured piece is required.

### 1. Spindle-end types

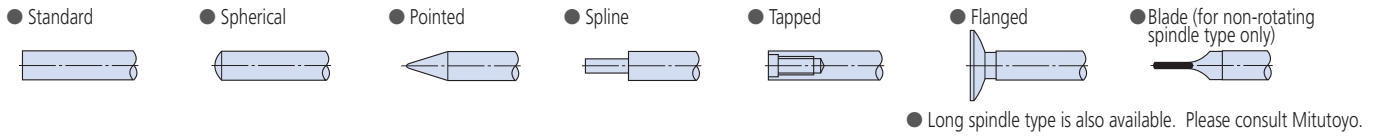

### 2. Stem types

A custom stem can be manufactured to suit the mounting fixture.

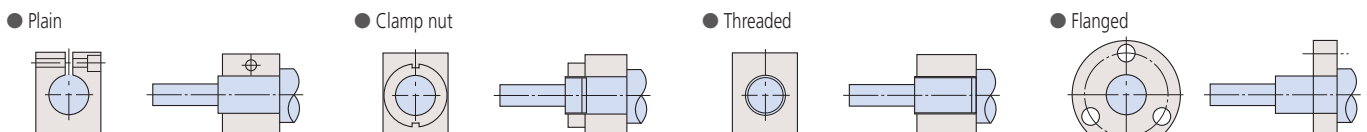

### 3. Scale graduation schemes

Various barrel and thimble scale graduation schemes, such as reverse and vertical, are available. Please consult Mitutoyo for ordering a custom scheme not shown here.

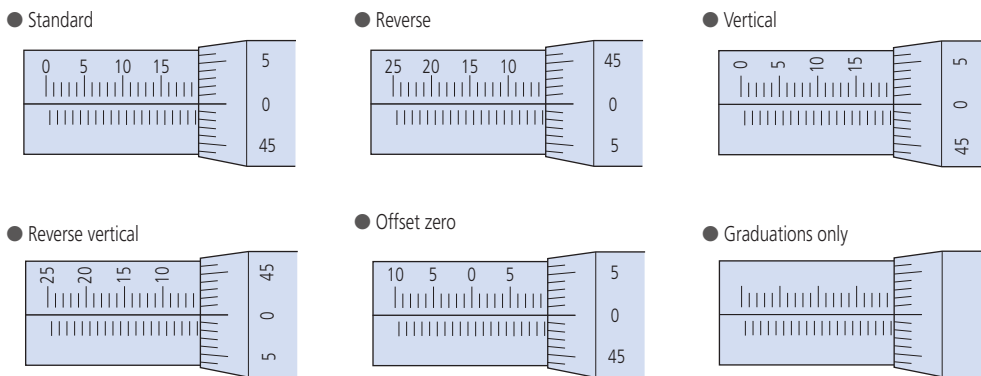

### 4. Logo engraving

A specific logo can be engraved as required.

### 5. Motor Coupling

Couplings for providing motor drive to a head can be designed.

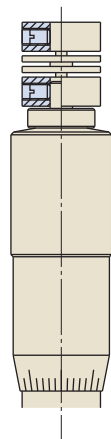

### 6. Thimble mounting

Thimble mounting methods including a ratchet, setscrew, and hex-socket head screw are available.

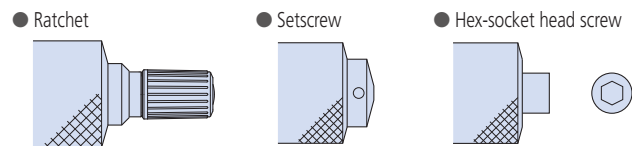

### 7. Spindle-thread pitch

Pitches of 1mm for fast-feed applications or 0.25mm for fine-feed can be supplied as alternatives to the standard 0.5mm. Inch pitches are also supported. Please consult Mitutoyo for details.

### 8. Lubricant for spindle threads

Lubrication arrangements can be specified by the customer.

### 9. All-stainless construction

All components of a head can be manufactured in stainless steel.

### 10. Simple packaging

Large-quantity orders of micrometer heads can be delivered in simple packaging for OEM purposes.

# Internal Micrometers

## Nomenclature

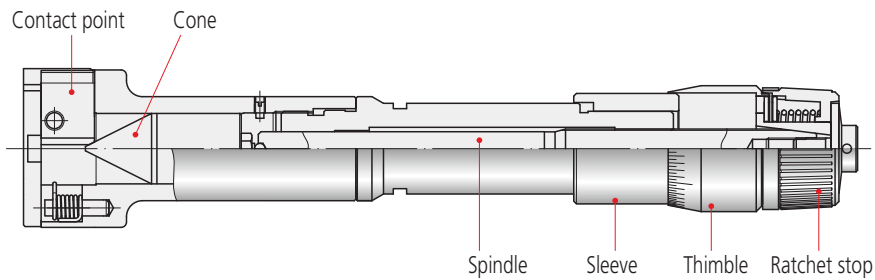

## Custom-ordered Products (Holtest / Borematic)

Mitutoyo can custom-build an internal micrometer best suited to your special application. Please feel free to contact Mitutoyo about the possibilities - even if only one custom-manufactured piece is required. Please note that, depending on circumstances, such a micrometer will usually need to be used with a master setting ring for accuracy assurance. (A custom-ordered micrometer can be made compatible with a master ring supplied by the customer. Please consult Mitutoyo.)

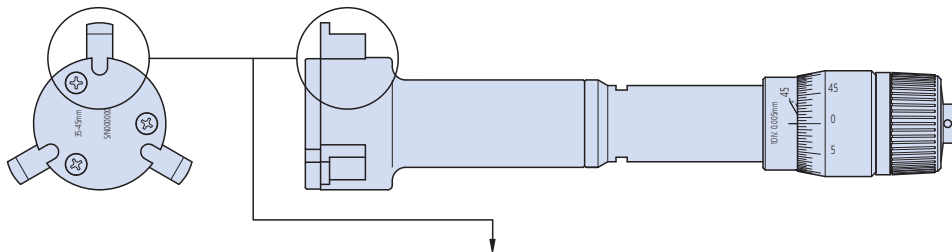

Type of feature	Workpiece profile (example)	Contact point tip profile (example)	Remarks
Square groove		<p>Tip radius R that can measure the minimum diameter (different for each size)</p> <p>W=1 or more</p>	<ul style="list-style-type: none"> <li>● Allows measurement of the diameter of variously shaped inside grooves and splines.</li> <li>● Minimum measurable groove diameter is approximately 16mm (differs depending on the workpiece profile.)</li> <li>● Dimension <math>l</math> should be as follows: For <math>W &lt; 2\text{mm}</math>: <math>l = \text{less than } 2\text{mm}</math> For <math>W = 2\text{mm}</math> or more: <math>l = 2\text{mm}</math> as the standard value which can be modified according to circumstances.</li> <li>● The number of splines or serrations is limited to a multiple of 3.</li> <li>● Details of the workpiece profile should be provided at the time of placing a custom-order.</li> <li>● If your application needs a measuring range different from that of the standard internal micrometer an additional initial cost for the master ring will be required.</li> </ul>
Round groove		<p>Tip radius R that can measure the minimum diameter (different for each size)</p> <p>W=1 or more</p> <p>Radius=0.5 or more</p>	
Spline		<p>W=0.5 or more</p> <p>Tip radius R that can measure the minimum diameter (different for each size)</p>	
Serration		<p>45° or more</p> <p>R=0.3 or more</p>	
Threaded hole			

## How to Read the Scale

Graduation 0.005mm

(1) Outer sleeve	35 mm
(2) Thimble	0.015 mm
Reading	35.015 mm

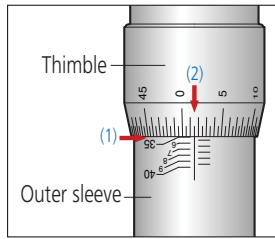

## Changes in measured values at different measuring points

When Holtest is used, the measured value differs between measurement across the anvil and the measurement only at the tip of the anvil due to the product mechanism. Adjust the start point under the same condition before measurement.

When you use the tip of the anvil for measurement, adjust the start point for using the tip of the anvil.

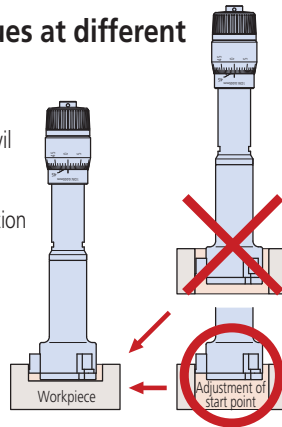

## Measurement error due to temperature variation of micrometer

Heat transfer from the operator to the micrometer should be minimized to avoid any significant measuring error due to temperature difference between the workpiece and micrometer. If the micrometer is held directly by hand when measuring, use gloves or hold the heat-insulator (if fitted).

## Misalignment Errors

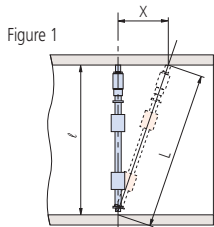

Figure 1  
 $l$ : Inside diameter to be measured  
 $L$ : Length measured with axial offset  $X$   
 $X$ : Offset in axial direction  
 $\Delta l$ : Error in measurement  
 $\Delta l: L - l = \sqrt{l^2 + X^2} - l$

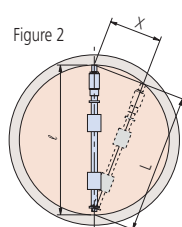
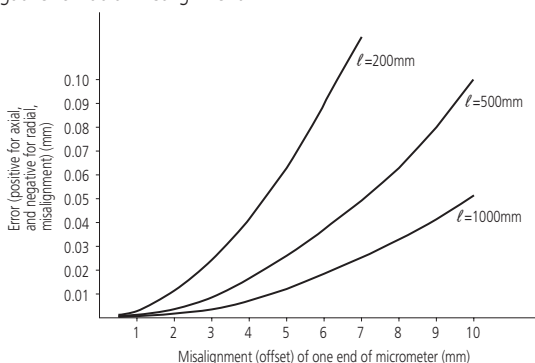

Figure 2  
 $l$ : Inside diameter to be measured  
 $L$ : Length measured with radial offset  $X$   
 $X$ : Offset in radial direction  
 $\Delta l$ : Error in measurement  
 $\Delta l: L - l = \sqrt{l^2 - X^2} - l$

If an inside micrometer is misaligned in the axial or radial direction by an offset distance  $X$  when a measurement is taken, as in Figures 1 and 2, then that measurement will be in error as shown in the graph below (constructed from the formulae given above). The error is positive for axial misalignment and negative for radial misalignment.



## Airy and Bessel Points

When a length standard bar or internal micrometer lies horizontally, supported as simply as possible at two points, it bends under its own weight into a shape that depends on the spacing of those points. There are two distances between the points that control this deformation in useful ways, as shown below.

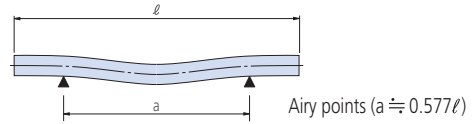

The ends of a bar (or micrometer) can be made exactly horizontal by spacing the two supports symmetrically as shown above. These points are known as the 'Airy Points' and are commonly used to ensure that the ends of a length bar are parallel to one another, so that the length is well defined.

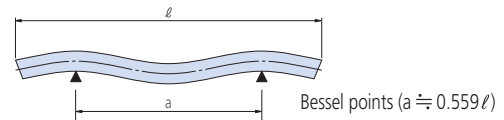

The change in length of a bar (or micrometer) due to bending can be minimized by spacing the two supports symmetrically as shown above. These points are known as the 'Bessel Points' and may be useful when using a long inside micrometer.

## Bore Gages

Mitutoyo bore gages for small holes feature contact elements with a large curvature so they can be easily positioned for measuring the true diameter (in the direction  $a-a'$ ) of a hole. The true diameter is the minimum value seen on the dial gage while rocking the bore gage as indicated by the arrow.

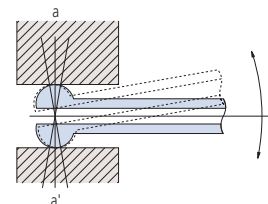

The spring-loaded guide plate on a Mitutoyo two-point bore gage automatically ensures radial alignment so that only an axial rocking movement is needed to find the minimum reading (true diameter).

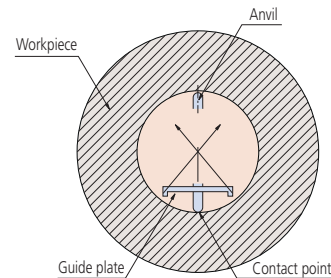

# Calipers

## Nomenclature

### Vernier Caliper

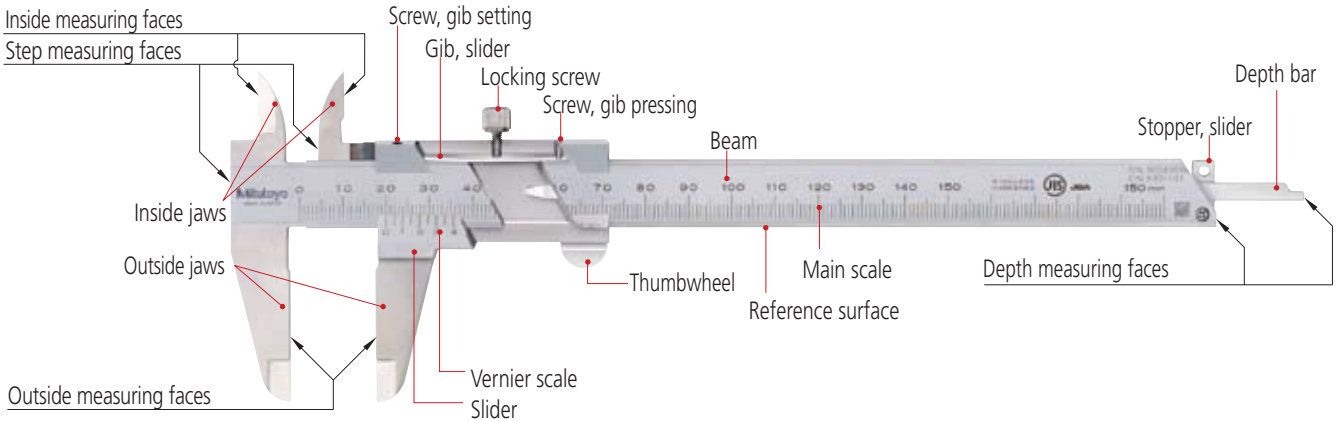

### Absolute Digimatic Caliper

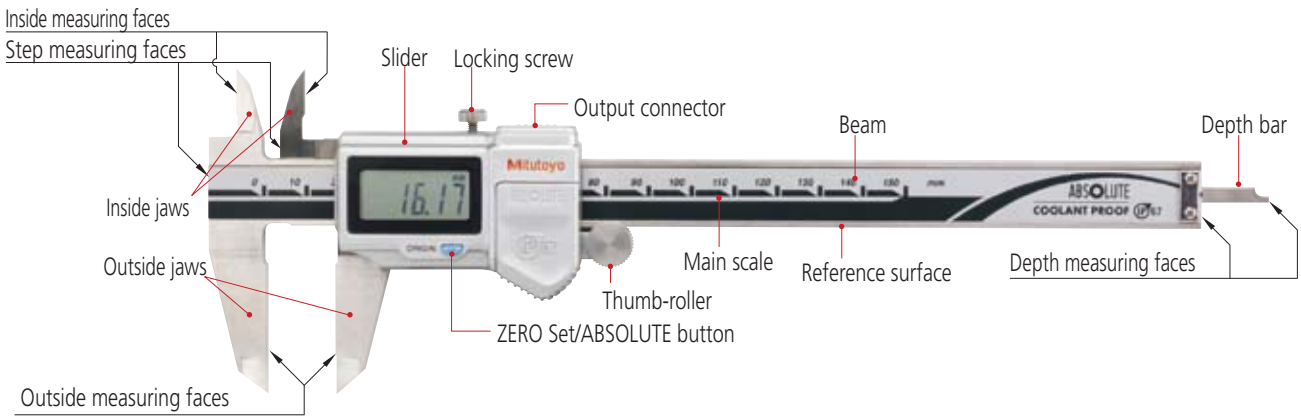

## How to Read the Scale

### Vernier Calipers

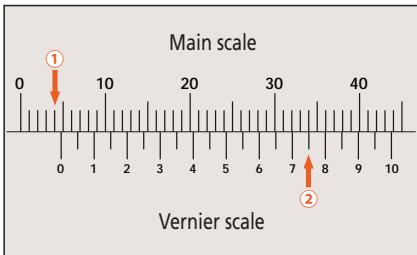

Graduation	0.05mm
(1) Main scale reading	4.00 mm
(2) Vernier scale reading	0.75 mm
Caliper reading	4.75 mm

### Dial Calipers

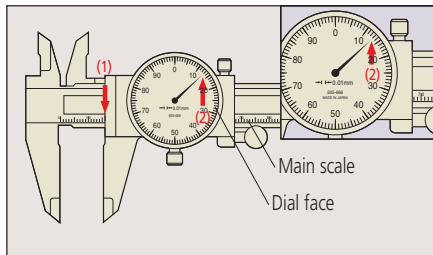

Graduation	0.01mm
(1) Main scale reading	16 mm
(2) Dial face reading	0.13 mm
Dial Caliper reading	16.13 mm

Note) Above left, 0.75 mm (2) is read at the position where a main scale graduation line corresponds with a vernier graduation line.

## Measurement examples

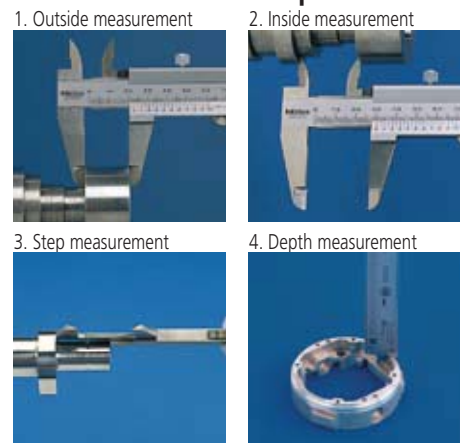

## Special Purpose Caliper Applications

### Point jaw type

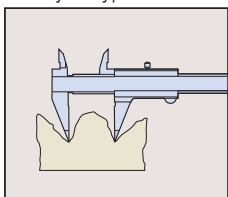

For uneven surface measurement

### Offset jaw type

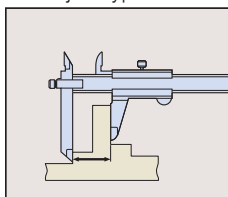

For stepped feature measurement

### Depth type

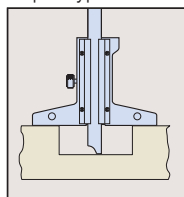

For depth measurement

### Blade jaw type

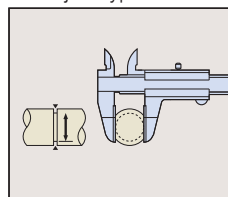

For diameter of narrow groove measurement

### Neck type

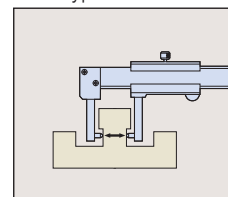

For outside diameter measurement such as thickness of recess

### Tube Thickness type

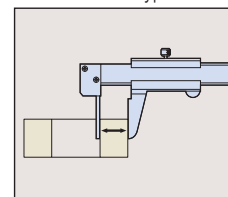

For pipe thickness measurement

## Types of Vernier Scale

The Vernier scale is attached to the caliper's slider and each division on this scale is made 0.05mm shorter than one main scale division of 1 mm. This means that, as the caliper jaws open, each successive movement of 0.05mm brings the succeeding vernier scale line into coincidence with a main scale line and so indicates the number of 0.05mm units to be counted (although for convenience the scale is numbered in fractions of a mm). Alternatively, one vernier division may be made 0.05mm shorter than two divisions of the main scale to make a long vernier scale. This makes the scale easier to read but the principle, and graduation, is still the same.

● Standard Vernier scale (graduation 0.05mm)

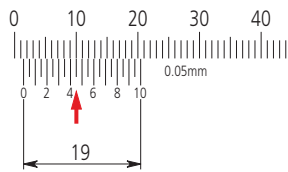

Reading 1.45mm

● Long Vernier scale (graduation 0.05mm)

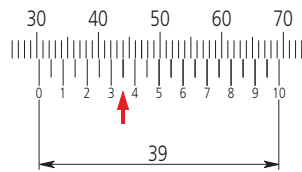

Reading 30.35mm

## About Long Calipers

Steel rules are commonly used to roughly measure large workpieces but if a little more accuracy is needed then a long caliper is suitable for the job. A long caliper is very convenient for its user friendliness but does require some care in use. In the first place it is important to realize there is no relationship between resolution and accuracy. For details, refer to the values in our catalog. Resolution is constant whereas the accuracy obtainable varies dramatically according to how the caliper is used.

The measuring method with this instrument is a concern since distortion of the main beam causes a large amount of the measurement error, so accuracy will vary greatly depending on the method used for supporting the caliper at the time. Also, be careful not to use too much measuring force when using the outside measuring faces as they are furthest away from the main beam so errors will be at a maximum here. This precaution is also necessary when using the tips of the outside measuring faces of a long-jaw caliper.

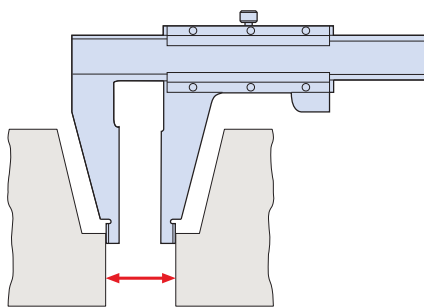

## Small hole measurement with an M-type caliper

A structural error  $d$  occurs when you measure the internal diameter of a small hole.

$\varnothing D$ : True internal diameter  
 $\varnothing d$ : Indicated internal diameter  
 $\Delta d$ : Measurement error ( $\varnothing D - \varnothing d$ )

True internal diameter ( $\varnothing D$ : 5mm)

H	0.3	0.5	0.7
$\Delta d$	0.009	0.026	0.047

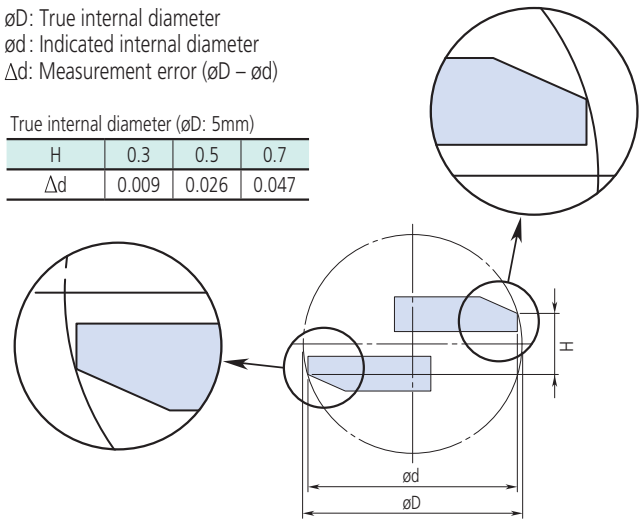

## Inside Measurement with a CM-type Caliper

Because the inside measuring faces of a CM-type caliper are at the tips of the jaws the measuring face parallelism is heavily affected by measuring force, and this becomes a large factor in the measurement accuracy attainable. In contrast to an M-type caliper, a CM-type caliper cannot measure a very small hole diameter because it is limited to the size of the stepped jaws, although normally this is no inconvenience as it would be unusual to have to measure a very small hole with this type of caliper. Of course, the radius of curvature on the inside measuring faces is always small enough to allow correct hole diameter measurements right down to the lowest limit (jaw closure). Mitutoyo CM-type calipers are provided with an extra scale on the slider for inside measurements so they can be read directly without the need for calculation, just as for an outside measurement. This useful feature eliminates the possibility of error that occurs when having to add the inside-jaw-thickness correction on a single-scale caliper.

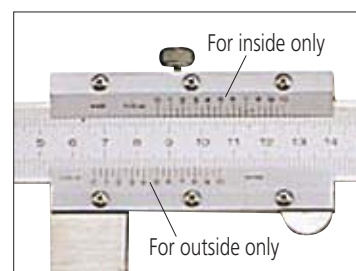

# Calipers

## General notes on use of caliper

### 1. Potential causes of error

A variety of factors can cause errors when measuring with a caliper. Major factors include parallax effects, excessive measuring force due to the fact that a caliper does not conform to Abbe's Principle, differential thermal expansion due to a temperature difference between the caliper and workpiece, and the effect of the thickness of the knife-edge jaws and the clearance between these jaws during measurement of the diameter of a small hole. Although there are also other error factors such as graduation accuracy, reference edge straightness, main scale flatness on the main blade, and squareness of the jaws, these factors are included within the instrumental error tolerances. Therefore, these factors do not cause problems as long as the caliper satisfies the instrumental error tolerances. Handling notes have been added to the JIS so that consumers can appreciate the error factors caused by the structure of the caliper before use. These notes relate to the measuring force and stipulate that "as the caliper does not have a constant-force device, you must measure a workpiece with an appropriate even measuring force. Take extra care when you measure it with the root or tip of the jaw because a large error could occur in such cases."

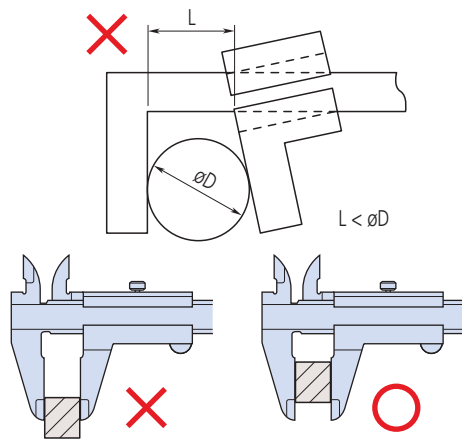

### 2. Inside measurement

Insert the inside jaw as deeply as possible before measurement. Read the maximum indicated value during inside measurement. Read the minimum indicated value during groove width measurement.

### 3. Depth measurement

Read the minimum indicated value during depth measurement.

### 4. Parallax error when reading the scales

Look straight at the vernier graduation line when checking the alignment of vernier graduation lines to the main scale graduation lines. If you look at a vernier graduation line from an oblique direction (A), the apparent alignment position is distorted by  $\Delta X$  as shown in the figure below due to a parallax effect caused by the step height (H) between the planes of the vernier graduations and the main scale graduations, resulting in a reading error of the measured value. To avoid this error, the JIS stipulates that the step height should be no more than 0.3 mm.

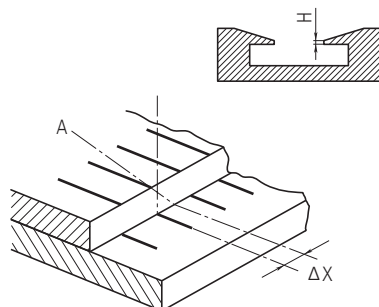

### 5. Moving Jaw Tilt Error

If the moving jaw becomes tilted out of parallel with the fixed jaw, either through excessive force being used on the slider or lack of straightness in the reference edge of the beam, a measurement error will occur as shown in the figure. This error may be substantial due to the fact that a caliper does not conform to Abbe's Principle.

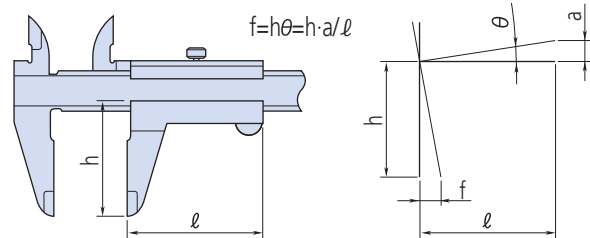

Example: Assume that the error slope of the jaws due to tilt of the slider is 0.01mm in 50mm and the outside measuring jaws are 40mm deep, then the error (at the jaw tip) is calculated as  $(40/50) \times 0.01 \text{ mm} = 0.008 \text{ mm}$ . If the guide face is worn then an error may be present even using the correct measuring force.

### 6. Relationship between measurement and temperature

The main scale of a caliper is engraved (or mounted on) stainless steel, and although the linear thermal expansion coefficient is equal to that of the most common workpiece material, steel, i.e.  $(10.2 \pm 1) \times 10^{-6} / \text{K}$ , note that other workpiece materials, the room temperature and the workpiece temperature may affect measurement accuracy.

### 7. Handling

Caliper jaws are sharp, and therefore the instrument must be handled with care to avoid personal injury. Avoid damaging the scale of a digital caliper and do not engrave an identification number or other information on it with an electric marker pen. Avoid damaging a caliper by subjecting it to impact with hard objects or by dropping it on a bench or the floor.

### 8. Maintenance of beam sliding surfaces and measuring faces

Wipe away dust and dirt from the sliding surfaces and measuring faces with a dry soft cloth before using the caliper.

### 9. Checking and setting the origin before use

Clean the measuring surfaces by gripping a sheet of clean paper between the outside jaws and then slowly pulling it out. Close the jaws and ensure that the vernier scale (or display) reads zero before using the caliper. When using a Digimatic caliper, reset the origin (ORIGIN button) after replacing the battery.

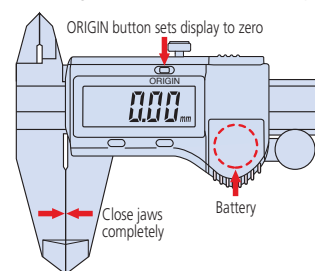

### 10. Handling after use

After using the caliper, completely wipe off any water and oil. Then, lightly apply anti-corrosion oil and let it dry before storage. Wipe off water from a waterproof caliper as well because it may also rust.

### 11. Notes on storage

Avoid direct sunlight, high temperatures, low temperatures, and high humidity during storage. If a digital caliper will not be used for more than three months, remove the battery before storage. Do not leave the jaws of a caliper completely closed during storage.

# Height Gages

## ■ Nomenclature

### Vernier Height Gage

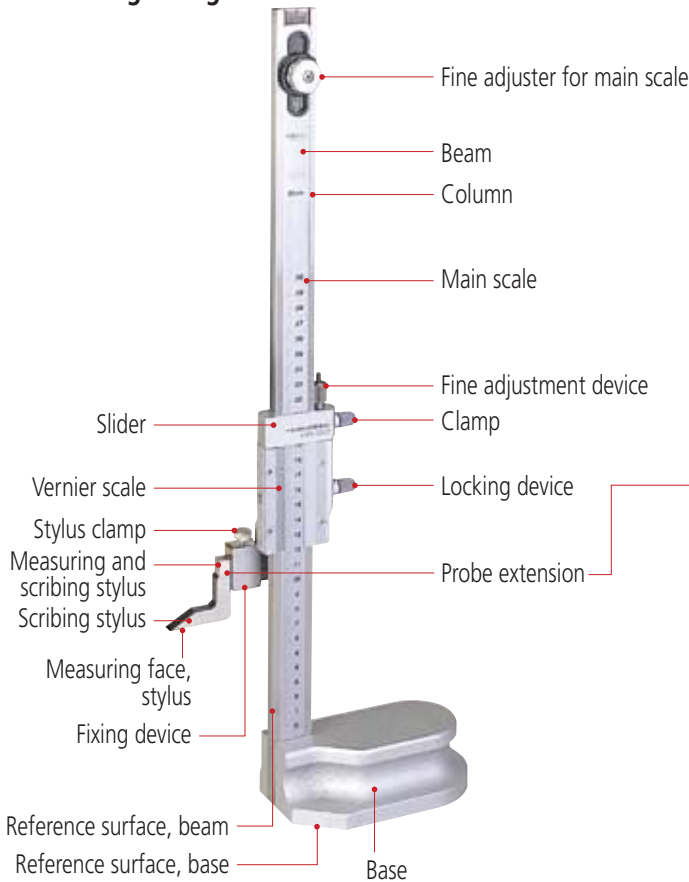

### Mechanical Digit Height Gage

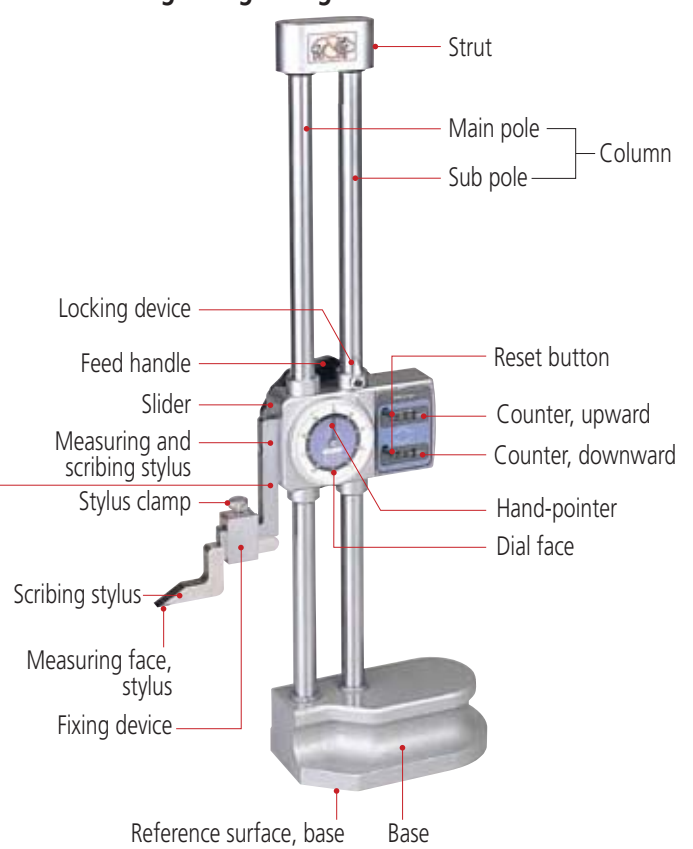

### Digimatic Height Gages

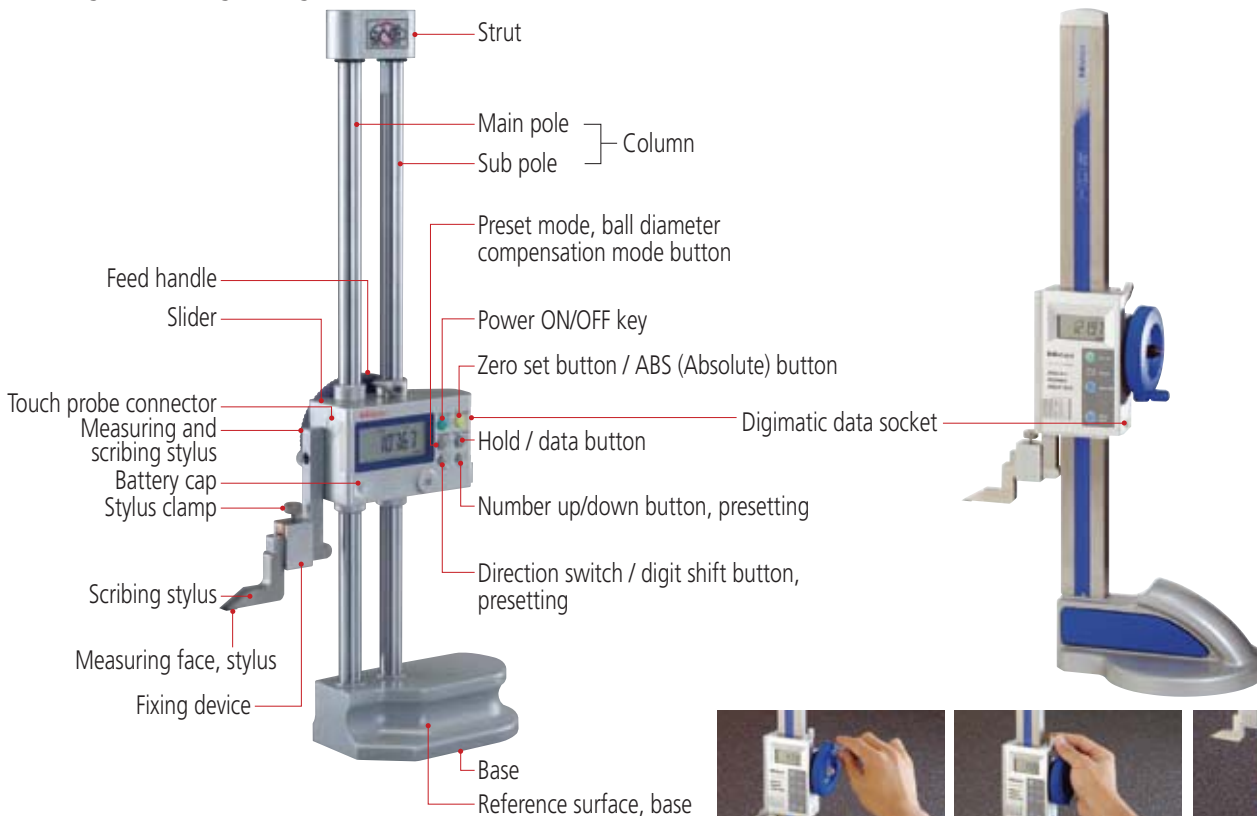

Slider handwheel



Slider clamping lever



Ergonomic base

# Height Gages

## How to read

### Vernier Height gage

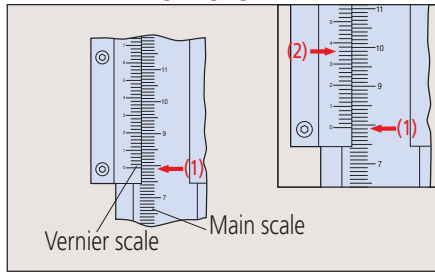

<b>Graduation</b>	<b>0.02mm</b>
(1) Main scale	79 mm
(2) Vernier	0.36 mm
<b>Reading</b>	<b>79.36 mm</b>

## General notes on use of Height Gages

### 1. Potential causes of error

Like the caliper, the error factors involved include parallax effects, error caused by excessive measuring force due to the fact that a height gage does not conform to Abbe's Principle, and differential thermal expansion due to a temperature difference between the height gage and workpiece. There are also other error factors caused by the structure of the height gage. In particular, the error factors related to a warped reference edge and scriber installation described below should be studied before use.

### 2. Reference edge (column) warping and scriber installation

Like the caliper, and as shown in the following figure, measurement errors result when using the height gage if the reference column, which guides the slider, becomes warped. This error can be represented by the same calculation formula for errors caused by nonconformance to Abbe's Principle.

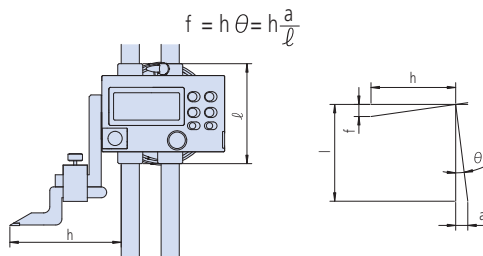

Installing the scriber (or a lever-type dial indicator) requires careful consideration because it affects the size of any error due to a warped reference column by increasing dimension  $h$  in the above formula. In other words, if an optional long scriber or lever-type dial indicator is used, the measurement error becomes larger.

Example: Effect of measuring point position  
When  $h$  is 150 mm, the error is 1.5 times larger than when  $h$  is 100 mm.

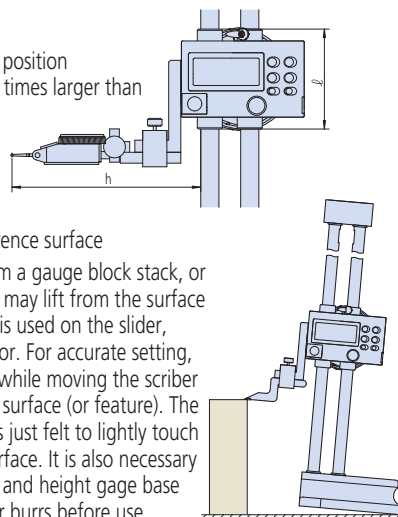

### 3. Lifting of the base from the reference surface

When setting the scriber height from a gauge block stack, or from a workpiece feature, the base may lift from the surface plate if excessive downwards force is used on the slider, and this results in measurement error. For accurate setting, move the slider slowly downwards while moving the scriber tip to and fro over the gauge block surface (or feature). The correct setting is when the scriber is just felt to lightly touch as it moves over the edge of the surface. It is also necessary to make sure that the surface plate and height gage base reference surface are free of dust or burrs before use.

### Mechanical Digit Height gage

#### Measuring upwards from a reference surface

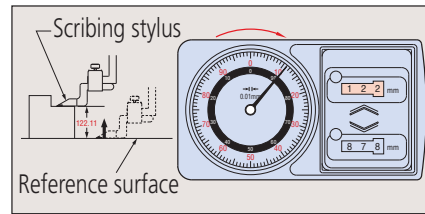

Counter	122 mm
Dial	0.11 mm
<b>Reading</b>	<b>122.11 mm</b>

#### Measuring downwards from a reference surface

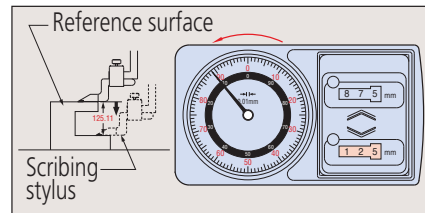

Counter	125 mm
Dial	0.11 mm
<b>Reading</b>	<b>125.11 mm</b>

### 4. Error due to inclination of the main scale (column)

According to JIS standards, the perpendicularity of the column reference edge to the base reference surface should be better than:

$$\left(0.01 + \frac{L}{1000}\right) \text{ mm} \quad L \text{ indicates the measuring length (unit: mm)}$$

This is not a very onerous specification. For example, the perpendicularity limit allowable is 0.61 mm when  $L$  is 600 mm. This is because this error factor has a small influence and does not change the inclination of the slider, unlike a warped column.

### 5. Relationship between accuracy and temperature

Height gages are made of several materials. Note that some combinations of workpiece material, room temperature, and workpiece temperature may affect measuring accuracy if this effect is not allowed for by performing a correction calculation.

- The tip of a height gage scriber is very sharp and must be handled carefully if personal injury is to be avoided.
- Do not damage a digital height gage scale by engraving an identification number or other information on it with an electric marker pen.
- Carefully handle a height gage so as not to drop it or bump it against anything.

## Notes on using the height gage

- Keep the column, which guides the slider, clean. If dust or dirt accumulates on it, sliding becomes difficult, leading to errors in setting and measuring.
- When scribing, securely lock the slider in position using the clamping arrangements provided. It is advisable to confirm the setting after clamping because the act of clamping on some height gages can alter the setting slightly. If this is so, allowance must be made when setting to allow for this effect.
- Parallelism between the scriber measuring face and the base reference surface should be 0.01 mm or better.  
Remove any dust or burrs on the mounting surface when installing the scriber or lever-type dial indicator before measurement. Keep the scriber and other parts securely fixed in place during measurement.
- If the main scale of the height gage can be moved, move it as required to set the zero point, and securely tighten the fixing nuts.
- Errors due to parallax error are not negligible. When reading a value, always look straight at the graduations.
- Handling after use: Completely wipe away any water and oil. Lightly apply a thin coating of anti-corrosion oil and let dry before storage.
- Notes on storage:  
Avoid direct sunlight, high temperatures, low temperatures, and high humidity during storage.  
If a digital height gage will not be used for more than three months, remove the battery before storage.  
If a protective cover is provided, use the cover during storage to prevent dust from adhering to the column.



# Gauge Blocks

## Definition of the Meter

The 17th General Conference of Weights and Measures in 1983 decided on a new definition of the meter unit as the length of the path traveled by light in a vacuum during a time interval of 1/299 792 458 of a second. The gauge block is the practical realization of this unit and as such is used widely throughout industry.

## Selection, Preparation and Assembly of a Gauge Block Stack

Select gauge blocks to be combined to make up the size required for the stack.

- (1) Take the following things into account when selecting gauge blocks.
  - a. Use the minimum number of blocks whenever possible.
  - b. Select thick gauge blocks whenever possible.
  - c. Select the size from the one that has the least significant digit required, and then work back through the more significant digits.
- (2) Clean the gauge blocks with an appropriate cleaning agent.
- (3) Check the measuring faces for burrs by using an optical flat as follows:

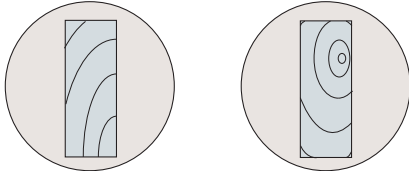

- a. Wipe each measuring face clean.
  - b. Gently place the optical flat on the gauge block measuring face.
  - c. Lightly slide the optical flat until interference fringes appear.
    - Judgment 1: If no interference fringes appear, it is assumed that there is a large burr or contaminant on the measuring face.
    - Judgment 2: If the interference fringes disappear, no burr exists on the measuring face.
    - Judgment 3: If some interference fringes remain locally while the flat is gently moved to and fro, a burr exists on the measuring face. If the fringes move along with the optical flat, there is a burr on the optical flat.
  - d. Lightly press the optical flat to check that the interference fringes disappear.
    - Judgment 2: If the interference fringes disappear, no burr exists on the measuring face.
    - Judgment 3: If some interference fringes remain locally while the flat is gently moved to and fro, a burr exists on the measuring face. If the fringes move along with the optical flat, there is a burr on the optical flat.
  - e. Remove burrs, if any, from the measuring face using a flat, fine-grained abrasive stone.
- (4) Apply a very small amount of oil to the measuring face and spread it evenly across the face. (Wipe the face until the oil film is almost removed.) Grease, spindle oil, vaseline, etc., are commonly used.

## Thermal Stabilization Time

The following figure shows the degree of dimensional change when handling a 100mm steel gauge block with bare hands.

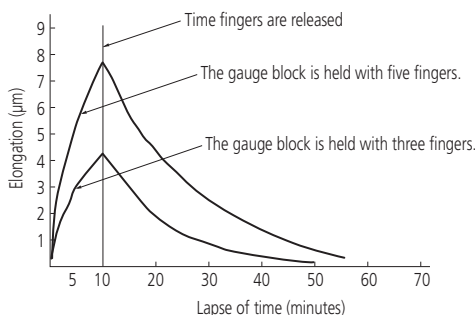

- (5) Gently overlay the faces of the gauge blocks to be wrung together. There are three methods to use (a, b and c as shown below) according to the size of blocks being wrung:

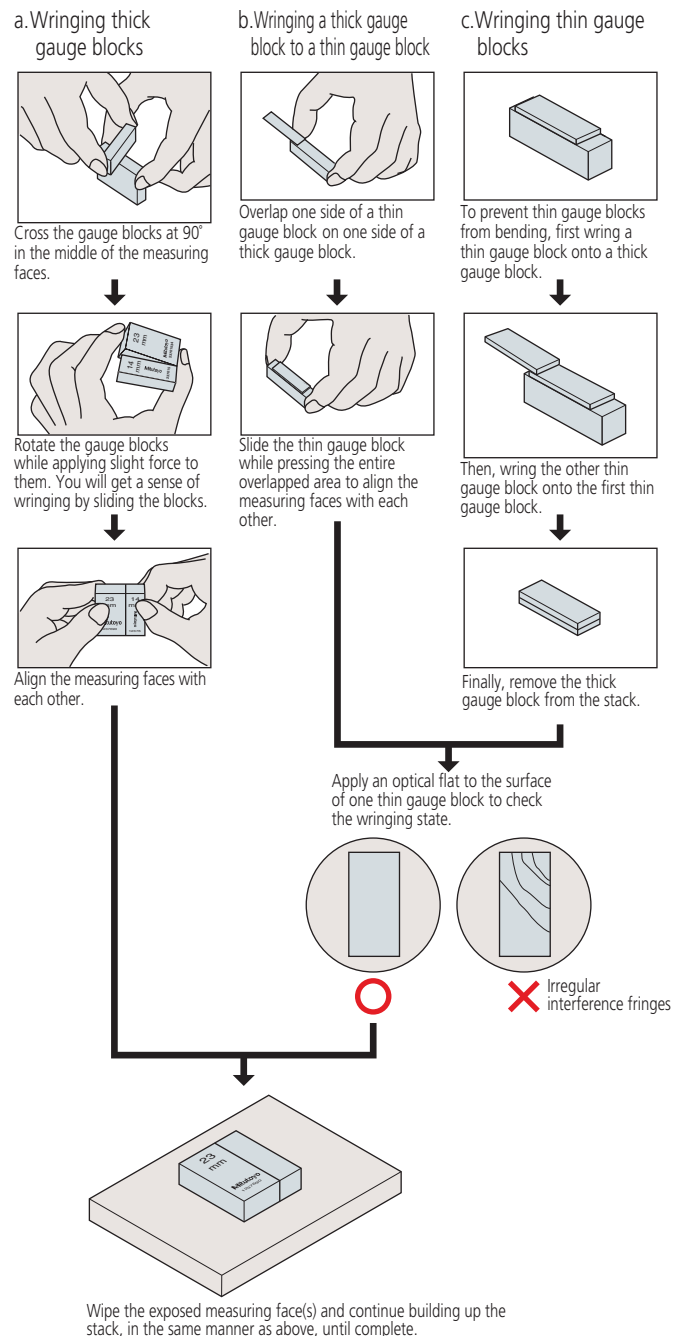

# Dial Gages and Digital Indicators

## Nomenclature



## Dial faces

### 0.01mm



Continuous dial (Bi-directional graduation)



Balanced dial (Multi-revolution)



Continuous dial (Reverse reading)



Balanced dial (One revolution)

### 0.001mm



Continuous dial (Standard scale spacing)



Balanced dial (Multi-revolution)



Continuous dial (Double scale spacing)



Balanced dial (One revolution)

- Continuous dial: For direct reading
- Balanced dial: For reading the difference from a reference surface
- Reverse reading dial: For depth or bore gage measurement
- One revolution dial: For error-free reading of small differences

## Mitutoyo's Response to Dial Indicator Standard B7503: 2011

- We guarantee the accuracy of completed products by inspecting them in the vertical posture. Standard-attached inspection certificate includes inspection data.
- We issue paid-for inspection certificates for horizontal or opposite posture if required.
- The old JIS Standard indicates that "the uncertainty of calibration" is evaluated inclusively. On the other hand, the new JIS Standard indicates that conformity or nonconformity to specification is verified based on JIS B 0641-1 and that it is preferred that the uncertainty is evaluated based on ISO/TS 14253-2 and ISO/IEC Guide 98. Therefore, we perform shipping inspection of dial indicators inclusive of the uncertainty of calibration as usual.

## Dial Indicator Standard B7503 : 2011 (Extract from JIS/Japanese Industrial Standards)

Item	Calibration method	Diagram of calibration setup in vertical posture (example)	Tools for calibration (example)
Indication error	Hold the dial indicator with its spindle set vertically downward, retract the spindle (retraction direction) to set the dial hand at the zero point, and determine the indication error at the below-mentioned measurement points with reference to the dial graduations. - Every 1/10 revolution for the first two revolutions - Every half revolution for the next five revolutions - Every revolution for the next 25 revolutions - Every 5 revolutions for after the 25th revolution For one revolution type dial indicators and indicators whose graduations are not factors of 10, determine the indicator errors at the closest measurement points mentioned above. Next, retract the spindle more than three graduations over the entire measuring range, reverse the spindle displacement (extension direction), and determine the indication errors at the same points measured during spindle retraction. Then determine the indication errors and the retrace errors with reference to the bidirectional indication errors thus obtained. When automatically reading errors by automatic inspection machine, determine the gap between the dial hand and the graduation mark with reference to the displacement of the measuring instrument.		For 0.01mm graduation dial indicators: A micrometer head or other measuring unit with 0.5μm graduation or less and instrumental error of ±1μm and a supporting stand. For dial indicators other than the above: A micrometer head or other measuring unit with 1μm graduation or less and ±1μm instrumental error and a supporting stand.
Retrace error			
Repeatability	Apply the contact point of the dial indicator perpendicularly to the upper face of a measuring stage, retract and extend the spindle quickly and slowly five times at a desired position within the measuring range and determine the maximum difference between the five indications obtained.		Measuring stage Supporting stand
Measuring Force	Holding a dial indicator, retract and extend the spindle continuously and gradually, and measure the measuring force at the zero, middle and end points in the measuring range. The largest value: maximum measurement force The smallest value: minimum measurement force The maximum difference in contact force measured when the spindle is retracting and extending at the same measuring position: difference in the measurement force		Supporting stand Top pan type spring scale (graduation: 0.02N or less) or force gage (sensitivity: 0.02N or less)

## Maximum permissible error

Graduation (mm)	Maximum permissible error (MPE) by measurement characteristics -- dial indicators with the bezel dia. 50mm or more								Maximum permissible error (MPE) by measurement characteristics -- dial indicators with the bezel dia. 50mm or less and back plunger type dial indicators										
	0.01								0.005	0.001			0.01				0.005	0.002	0.001
Measuring range (mm)	1 or less	Over 1 and up to 3	Over 3 and up to 5	Over 5 and up to 10	Over 10 and up to 20	Over 20 and up to 30	Over 30 and up to 50	Over 50 and up to 100	5 or less	1 or less	Over 1 and up to 2	Over 2 and up to 5	1 or less	Over 1 and up to 3	Over 3 and up to 5	Over 5 and up to 10	5 or less	1 or less	1 or less
Retrace error	3	3	3	3	5	7	8	9	3	2	2	3	4	4	4	5	3.5	2.5	2
Repeatability	3	3	3	3	4	5	5	5	3	0.5	0.5	1	3	3	3	3	3	1	1
Indication error	Arbitrary 1/10 revolution	5	5	5	5	8	10	10	5	2	2	3.5	8	8	8	9	6	2.5	2.5
	Arbitrary 1/2 revolution	8	8	9	9	10	12	12	9	3.5	4	5	11	11	12	12	9	4.5	4
	Arbitrary One revolution	8	9	10	10	15	15	15	10	4	5	6	12	12	14	14	10	5	4.5
	Entire measuring range	8	10	12	15	25	30	40	50	12	5	7	10	15	16	18	20	12	6

MPE for one revolution type dial indicators does not define the indication error of arbitrary 1/2 and 1 revolution.

\* Values in the table above apply at 20°C, which JIS B0680 defines as the standard temperature.

\* The measurement characteristics of a dial indicator have to meet both maximum permissible error (MPE) and measurement force permissible limits (MPL) at any position within the measuring range in any posture when the measurement characteristics are not specified by the manufacturer.

# Dial Gages and Digital Indicators

## ■ Mounting a Dial gage

Stem mounting	Method	<p>Clamping the stem directly with a screw</p>	<p>Clamping the stem by split-clamp fastening</p>
	Note	<ul style="list-style-type: none"> <li>• Mounting hole tolerance: <math>\varnothing 8G7(+0.005</math> to <math>0.02)</math></li> <li>• Clamping screw: M4 to M6</li> <li>• Clamping position: 8mm or more from the lower edge of the stem</li> <li>• Maximum clamping torque: 150N-cm when clamping with a single M5 screw</li> <li>• Note that excessive clamping torque may adversely affect spindle movement.</li> </ul>	<ul style="list-style-type: none"> <li>• Mounting hole tolerance: <math>\varnothing 8G7(+0.005</math> to <math>0.02)</math></li> </ul>
Lug mounting	Method		
	Note	<ul style="list-style-type: none"> <li>• Lugs can be changed 90 degrees in orientation according to the application. (The lug is set horizontally when shipped.)</li> <li>• Lugs of some Series 1 models (No.1911,1913-10&amp;1003), however, cannot be altered to horizontal.</li> <li>• To avoid cosine-effect error, ensure that any type of gage or indicator is mounted with its spindle in line with the intended measurement direction.</li> </ul>	

## ■ Contact element

- Screw thread is standardized on M2.5x0.45 (Length: 5mm).
- Incomplete thread section at the root of the screw shall be less than 0.7mm when fabricating a contact point.

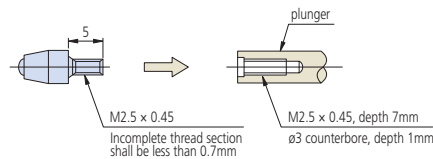

## ■ Effect of orientation on measuring force

Position	Remarks
<p>Contact element down (normal position)</p>	<p>If measurement is performed with the plunger horizontal or contact element up, the measuring force is less than when the contact element is down. In this case be sure to check the operation and repeatability of the indicator or digital display. For guaranteed-operation specifications according to positions of digital indicators and dial gages, refer to the product descriptions in a general catalog.</p>
<p>Plunger horizontal (lateral position)</p>	
<p>Contact element up (upside-down position)</p>	

## ■ Setting the origin of a digital indicator

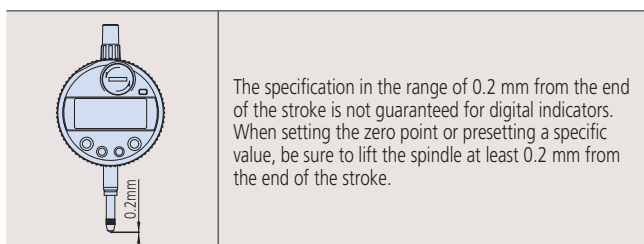

## ■ Care of the plunger

- Do not lubricate the plunger. Doing so might cause dust to accumulate, resulting in a malfunction.
- If the plunger movement is poor, wipe the upper and lower plunger surfaces with a dry or alcohol-soaked cloth. If the movement is not improved by cleaning, contact Mitutoyo for repair.
- Before making a measurement or calibration, please confirm if the spindle moves upward and downward smoothly, and stability of zero point.

## Dial Test Indicator Standard B7533-1990 (Extract from JIS/Japanese Industrial Standards)

No.	Item	Calibration method	Diagram of calibration setup	Tools for calibration	
1	Wide-range accuracy	(1) For an indicator of 0.01 mm graduation: Displace the contact point so as to move the pointer clockwise in increments of 0.1 mm with reference to the graduations from the zero point to the end point of the measuring range while taking readings of the calibration tool at each point and determine this accuracy from the error curve drawn by plotting the differences of each "indicator reading - calibration tool reading". (2) For an indicator of 0.002 mm graduation: Displace the contact point so as to move the pointer clockwise in increment of 0.02 mm with reference to the graduations from the zero point to the end point of the measuring range while taking readings of the calibration tool at each point and determine this accuracy from the error curve drawn by plotting the differences of each "indicator reading - calibration tool reading". The instrumental error of the calibration tool shall be compensated prior to this measurement.		Micrometer head or measuring unit (graduation: 1 μm or less, instrumental error: within ±1 μm), supporting stand	
2	Adjacent error				
3	Retrace error	After the completion of the wide-range accuracy measurement, reverse the contact point from the last point of measurement while taking readings at the same scale graduations as for the wide-range accuracy measurement and determine the retrace error from the error curve plotted.			
4	Repeatability	a	Holding the dial test indicator with its stylus parallel with the top face of the measuring stage, displace the contact point quickly and slowly five times at a desired position within the measuring range and determine the maximum difference in indication.		Measuring stage, Supporting stand, and Gauge block of grade 1 as stipulated by JIS B7506 (Gauge block)
		b	Holding the stylus parallel to a gauge block placed on the measuring stage, move the gauge block to and fro and left to right under the contact point within the measuring range and determine the maximum difference in indication.		
5	Measuring force	Holding an indicator by the case or stem, displace the contact point gradually and continuously in the forward and backward directions respectively and take a reading of measuring force at the zero, middle and end points of the measuring range in each direction. • Performance The maximum measuring force in the forward direction shall not exceed 0.5N. The difference between the maximum and minimum measuring forces in one direction shall not exceed 0.2N (20gf). Note that the smallest possible measuring force is desirable for indicators.		Top pan type spring scale (graduation: 2gf or less) or force gage (sensitivity: 0.02N or less)	

Notes: There are no JIS standards applicable to models with a graduation of 0.001 mm. Therefore, referring to JIS B 7533-1990 for inspecting the wide-range accuracy and adjacent error, the accuracy is measured by moving the contact point 0.01 mm clockwise from the start point of the measuring range to the end point with reference to the graduations.

### ● Accuracy of indication

Permissible indication errors of dial test indicators are as per the table below.

Graduation (mm)	Measuring range (mm)	Wide range accuracy	Adjacent error	Repeatability	Retrace error
0.01	0.5	5	5	3	3
	0.8	8			
	1.0	10			4*1
0.002	0.2	3	2	1	2
	0.28				

\*1: Applies to indicators with a stylus over 35 mm long.  
Remarks: Values in the table above apply at 20°C.

### ■ Dial Test Indicators and the Cosine Effect

Always minimize the angle between movement directions during use.

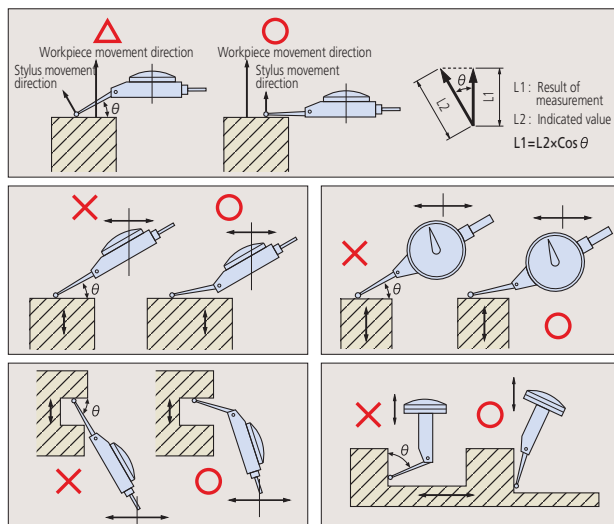

The reading of any indicator will not represent an accurate measurement if its measuring direction is misaligned with the intended direction of measurement (cosine effect). Because the measuring direction of a dial test indicator is at right angles to a line drawn through the contact point and the stylus pivot, this effect can be minimized by setting the stylus to minimize angle  $\theta$  (as shown in the figures). If necessary, the dial reading can be compensated for the actual  $\theta$  value by using the table below to give the result of measurement.  
Result of measurement = indicated value x compensation value

#### Compensating for a non-zero angle

Angle	Compensation value
10°	0.98
20°	0.94
30°	0.86
40°	0.76
50°	0.64
60°	0.50

#### Examples

If a 0.200mm measurement is indicated on the dial at various values of  $\theta$ , the result of measurements are:  
For  $\theta = 10^\circ$ ,  $0.200\text{mm} \times 0.98 = 0.196\text{mm}$   
For  $\theta = 20^\circ$ ,  $0.200\text{mm} \times 0.94 = 0.188\text{mm}$   
For  $\theta = 30^\circ$ ,  $0.200\text{mm} \times 0.86 = 0.172\text{mm}$

Note: A special contact point of involute form can be used to apply compensation automatically and allow measurement to be performed without manual compensation for any angle  $\theta$  from 0 to 30°. (This type of contact point is custom-made.)

# Linear Gages

## Head

### Plain Stem and Stem with Clamp Nut

The stem used to mount a linear gage head is classified as a "plain type" or "clamp nut type" as illustrated below. The clamp nut stem allows fast and secure clamping of the linear gage head. The plain stem has the advantage of wider application and slight positional adjustment in the axial direction on final installation, although it does require a split-fixture clamping arrangement or adhesive fixing. However, take care so as not to exert excessive force on the stem.

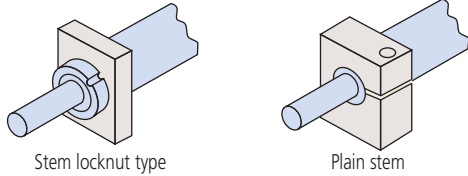

### Measuring Force

This is the force exerted on a workpiece during measurement by the contact point of a linear gage head, at its stroke end, expressed in newtons.

### Comparative Measurement

A measurement method where a workpiece dimension is found by measuring the difference in size between the workpiece and a master gage representing the nominal workpiece dimension.

### Ingress Protection Code

#### IP54 protection code

Type	Level	Description
Protects the human body and protects against foreign objects	5: Dust protected	Protection against harmful dust
Protects against exposure to water	4: Splash-proof type	Water splashing against the enclosure from any direction shall have no harmful effect.

#### IP66 protection code

Type	Level	Description
Protection against contact with the human body and foreign objects	6: Dust tight	Protection from dust ingress Complete protection against contact
Protects against exposure to water	6: Water-resistant type	Water jets directed against the enclosure from any direction shall have no harmful effects.

### Precautions in Mounting a Gage Head

- Insert the stem of the gage into the mounting clamp of a measuring unit or a stand and tighten the clamp screw.
- Notice that excessively tightening the stem can cause problems with spindle operation.
- Never use a mounting method in which the stem is clamped by direct contact with a screw.
- Never mount a linear gage by any part other than the stem.
- Mount the gage head so that it is in line with the intended direction of measurement. Mounting the head at an angle to this direction will cause an error in measurement.
- Exercise care so as not to exert a force on the gage through the cable.

### Precautions in Mounting a Laser Hologage

To fix the Laser Hologage, insert the stem into the dedicated stand or fixture.

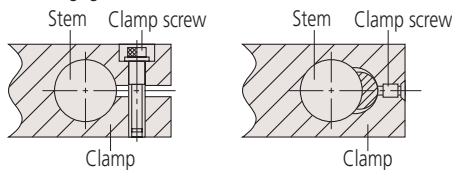

Recommended hole diameter on the fixing side: 15mm +0.034/+0.014

- Machine the clamping hole so that its axis is parallel with the measuring direction. Mounting the gage at an angle will cause a measuring error.
- When fixing the Laser Hologage, do not clamp the stem too tightly. Over-tightening the stem may impair the sliding ability of the spindle.
- If measurement is performed while moving the Laser Hologage, mount it so that the cable will not be strained and no undue force will be exerted on the gage head.

## Display Unit

### Zero-setting

A display value can be set to 0 (zero) at any position of the spindle.

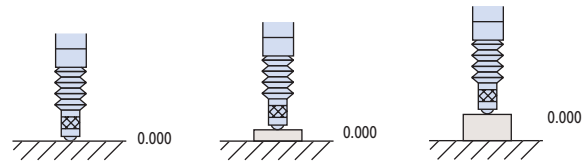

### Presetting

Any numeric value can be set on the display unit for starting the count from this value.

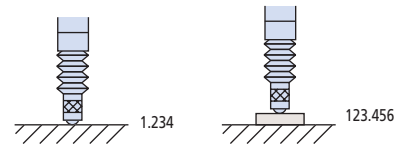

### Direction changeover

The measuring direction of the gage spindle can be set to either plus (+) or minus (-) of count.

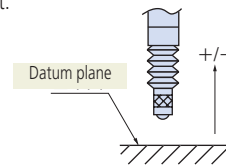

### MAX, MIN, TIR Settings

The display unit can hold the maximum (MAX) and minimum (MIN) values, and MAX - MIN value during measurement.

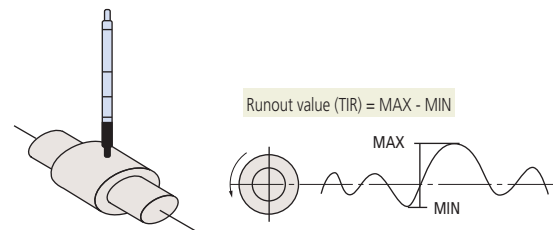

### Tolerance Setting

Tolerance limits can be set in various display units for automatically indicating if a measurement falls within those limits.

### Open Collector Output

An external load, such as a relay or a logic circuit, can be driven from the collector output of an internal transistor which is itself controlled by a Tolerance Judgement result, etc.

### Relay output

Contact signal that outputs the open/closed status.

### Digimatic Code

A communication protocol for connecting the output of measuring tools with various Mitutoyo data processing units. This allows output connection to a Digimatic Mini Processor DP-1VR for performing various statistical calculations and creating histograms, etc.

### BCD Output

A system for outputting data in binary-coded decimal notation.

### RS-232C Output

A serial communication interface in which data can be transmitted bi-directionally under the EIA Standards. For the transmission procedure, refer to the specifications of each measuring instrument.

## RS Link Function

Multi-point measurement can be performed by connecting multiple EH or EV counters with RS Link cables.

### ■ RS Link for EH Counter

It is possible to connect a maximum of 10 counter units and handle up to 20 channels of multi-point measurement at a time. For this connection use a dedicated RS Link cable **No.02ADD950** (0.5m), **No.936937** (1m) or **No.965014** (2m). (The total length of RS Link cables permitted for the entire system is up to 10m.)

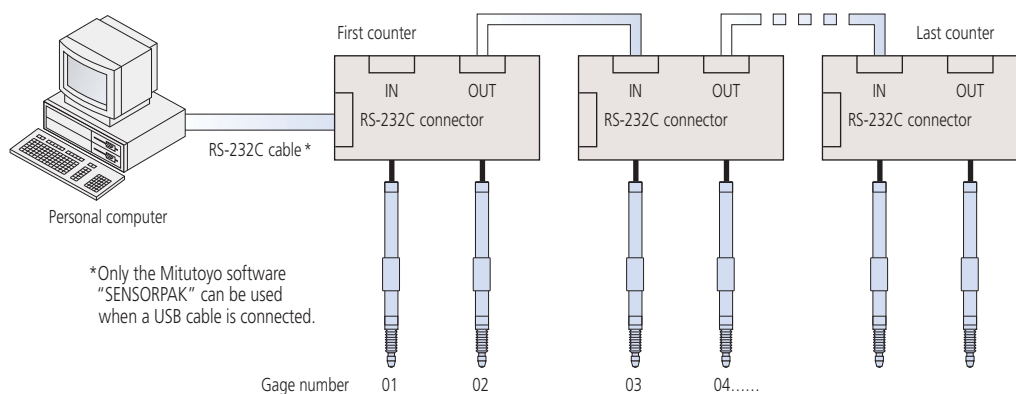

### ■ RS Link for EV Counter

It is possible to connect a maximum of 10\* counter units and handle up to 60 channels of multi-point measurement at a time. For this connection use a dedicated RS Link cable **No.02ADD950** (0.5m), **No.936937** (1m) or **No.965014** (2m). (The total length of RS Link cables permitted for the entire system is up to 10m.)

\* The maximum number of counter units that can be connected is limited to 6 (six) if an EH counter is included in the chain.

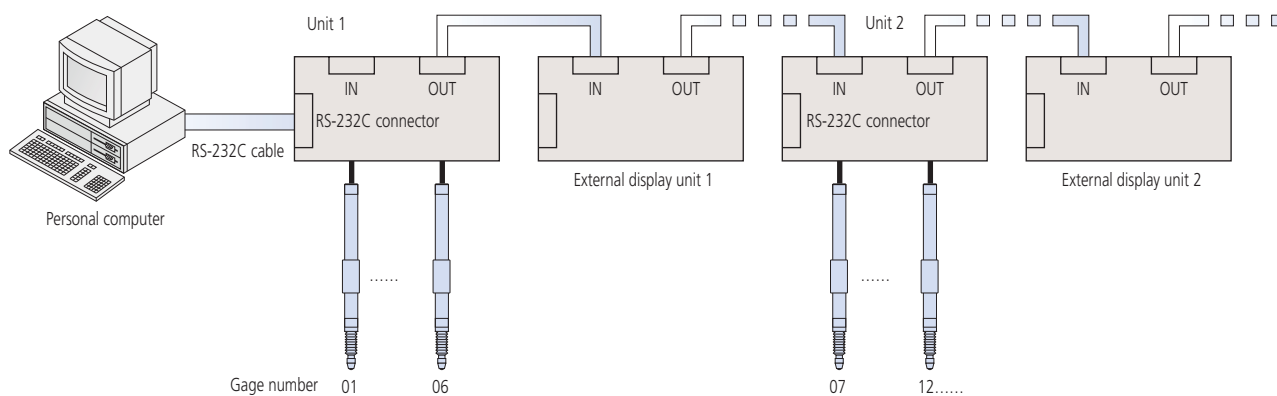

# Laser Scan Micrometers

## Compatibility

Your Laser Scan Micrometer has been adjusted together with the ID Unit, which is supplied with the measuring unit. The ID Unit, which has the same code number and the same serial number as the measuring unit, must be installed in the display unit. This means that if the ID Unit is replaced the measuring unit can be connected to another corresponding display unit.

## The workpiece and measuring conditions

Depending on whether the laser is visible or invisible, the workpiece shape, and the surface roughness, measurement errors may result. If this is the case, perform calibration with a master workpiece which has dimensions, shape, and surface roughness similar to the actual workpiece to be measured. If measurement values show a large degree of dispersion due to the measuring conditions, increase the number of scans for averaging to improve the measurement accuracy.

## Electrical interference

To avoid operational errors, do not route the signal cable and relay cable of the Laser Scan Micrometer alongside a highvoltage line or other cable capable of inducing noise current in nearby conductors. Ground all appropriate units and cable shields.

## Connection to a computer

If the Laser Scan Micrometer is to be connected to an external personal computer via the RS-232C interface, ensure that the cable connections conform to the specification.

## Laser safety

Mitutoyo Laser Scan Micrometers use a low-power visible laser for measurement. The laser is a CLASS 2 EN/IEC60825-1 (2007) device. Warning and explanation labels, as shown right, are attached to the Laser Scan Micrometers as is appropriate.



## Re-assembly after removal from the base

Observe the following limits when re-assembling the emission unit and reception unit to minimize measurement errors due to misalignment of the laser's optical axis with the reception unit.

### Alignment within the horizontal plane

- a. Parallel deviation between reference lines C and D: X (in the transverse direction)

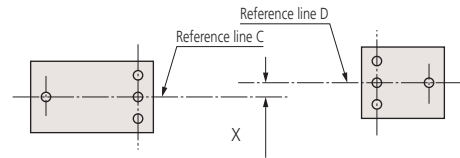

- b. Angle between reference lines C and D:  $\theta_x$  (angle)

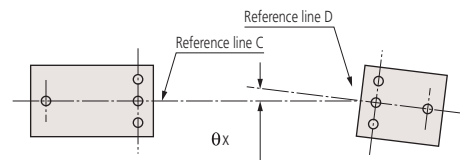

### Alignment within the vertical plane

- c. Parallel deviation between reference planes A and B: Y (in height)

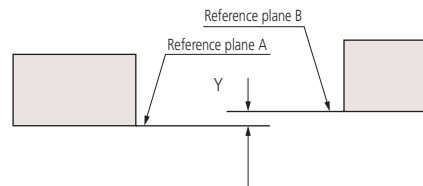

- d. Angle between reference planes A and B:  $\theta_y$  (angle)

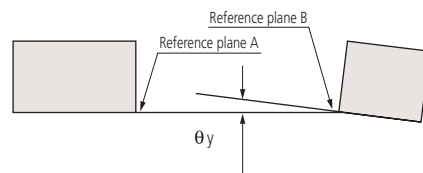

## Allowable limits of optical axis misalignment

Model	Distance between Emission Unit and Reception Unit	X and Y	$\theta_x$ and $\theta_y$
LSM-501S	68mm ( 2.68" ) or less	within 0.5mm (.02")	within 0.4' (7mrad)
	100mm ( 3.94" ) or less	within 0.5mm (.02")	within 0.3' (5.2mrad)
LSM-503S	130mm ( 5.12" ) or less	within 1mm (.04")	within 0.4' (7mrad)
	350mm (13.78" ) or less	within 1mm (.04")	within 0.16' (2.8mrad)
LSM-506S	273mm (10.75" ) or less	within 1mm (.04")	within 0.2' (3.5mrad)
	700mm (27.56" ) or less	within 1mm (.04")	within 0.08' (1.4mrad)
LSM-512S	321mm (12.64" ) or less	within 1mm (.04")	within 0.18' (3.6mrad)
	700mm (27.56" ) or less	within 1mm (.04")	within 0.08' (1.4mrad)
LSM-516S	800mm (31.50" ) or less	within 1mm (.04")	within 0.05' (0.9mrad)



## Measurement Examples

On-line measurement of glass fiber or fine wire diameter

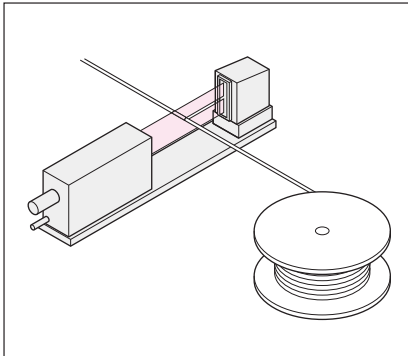

Measurement of outer diameter of cylinder

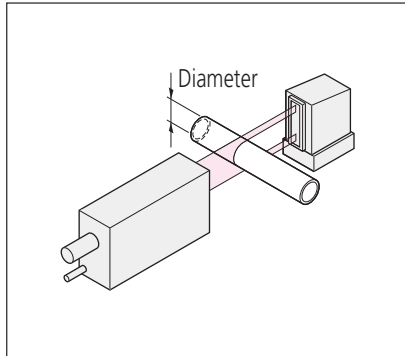

Measurement of outer diameter and roundness of cylinder

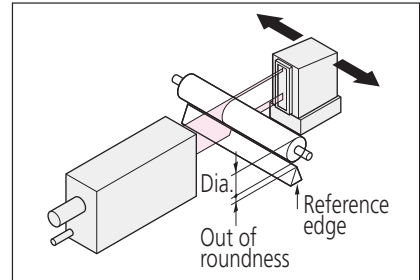

X- and Y-axis measurement of electric cables and fibers

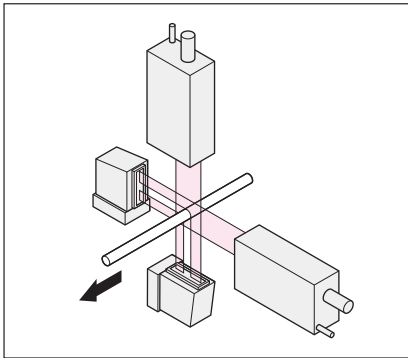

Measurement of thickness of film and sheet

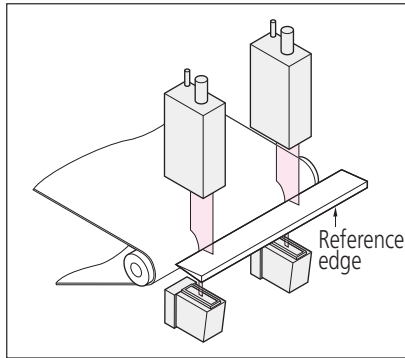

Measurement of spacing of IC chip leads

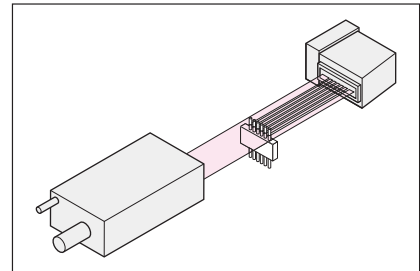

Measurement of film sheet thickness

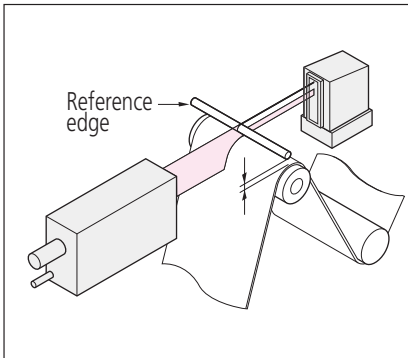

Measurement of laser disk and magnetic disk head movement

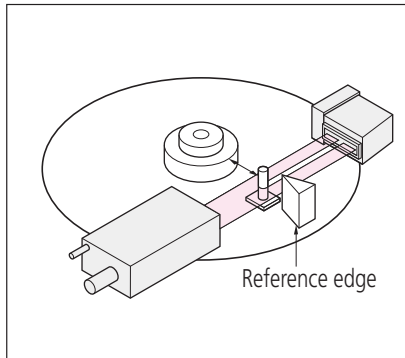

Measurement of gap between rollers

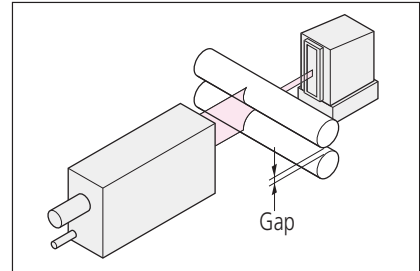

Measurement of tape width

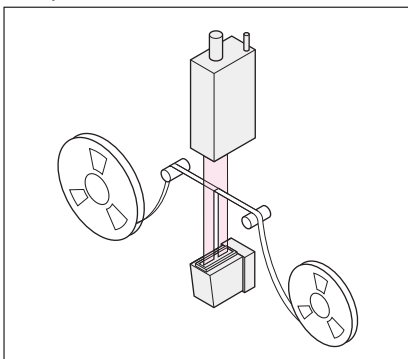

Measurement of outer diameter of optical connector and ferrule

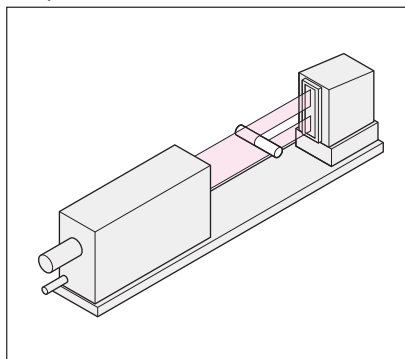

Measurement of form

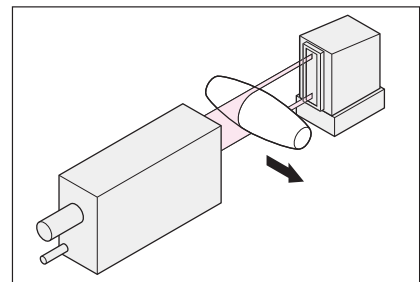

Dual system for measuring a large outside diameter

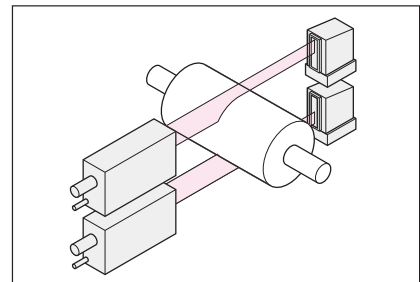

# Linear Scales

## Tests for Evaluating Linear Scales

### 1. Testing within the service temperature range

Confirms that there is no performance abnormality of a unit within the service temperature range and that data output is according to the standard.

### 2. Temperature cycle (dynamic characteristics) test

Confirms that there is no performance abnormality of a unit during temperature cycling while operating and that data output is according to the standard.

### 3. Vibration test (Sweep test)

Confirms that there is no performance abnormality of a unit while subject to vibrations of a frequency ranging from 30Hz to 300Hz with a maximum acceleration of  $3g_n$ .

### 4. Vibration test (Acceleration test)

Confirms that there is no performance abnormality of a unit subject to vibrations at a specific, non-resonant frequency.

### 5. Noise test

The noise test conforms to EMC Directive EN61326-1+A1:1998.

### 6. Package drop test

This test conforms to JISZ0200 (Heavy duty material drop test)

## Glossary

### ■ Absolute system

A measurement mode in which every point measurement is made relative to a fixed origin point.

### ■ Incremental system

A measurement mode in which every point measurement is made relative to a certain stored reference point.

### ■ Origin offset

A function that enables the origin point of a coordinate system to be translated to another point offset from the fixed origin point. For this function to work, a system needs a permanently stored origin point.

### ■ Restoring the origin point

A function that stops each axis of a machine accurately in position specific to the machine while slowing it with the aid of integrated limit switches.

### ■ Sequence control

A type of control that sequentially performs control steps according to a prescribed order.

### ■ Numerical control

A way of controlling the movements of a machine by encoded commands created and implemented with the aid of a computer (CNC). A sequence of commands typically forms a 'part program' that instructs a machine to perform a complete operation on a workpiece.

### ■ Binary output

Refers to output of data in binary form (ones and zeros) that represent numbers as integer powers of 2.

### ■ RS-232C

An interface standard that uses an asynchronous method of serial transmission of data over an unbalanced transmission line for data exchange between transmitters located relatively close to each other. It is a means of communication mainly used for connecting a personal computer with peripherals.

### ■ Line driver output

This output features fast operating speeds of several tens to several hundreds of nanoseconds and a relatively long transmission distance of several hundreds of meters. A differential-voltmeter line driver (RS422A compatible) is used as an I/F to the NC controller in the linear scale system.

### ■ BCD

A notation of expressing the numerals 0 through 9 for each digit of a decimal number by means of four-bit binary sequence. Data transmission is one-way output by means of TTL or open collector.

### ■ RS-422

An interface standard that uses serial transmission of bits in differential form over a balanced transmission line. RS-422 is superior in its data transmission characteristics and in its capability of operating with only a single power supply of +5V.

### ■ Accuracy

The accuracy specification of a scale is given in terms of the maximum error to be expected between the indicated and true positions at any point, within the range of that scale, at a temperature of 20°C. Since there is no international standard defined for scale units, each manufacturer has a specific way of specifying accuracy. The accuracy specifications given in our catalog have been determined using laser interferometry.

### ■ Narrow range accuracy

Scale gratings on a scale unit normally adopt 20µm pitch though it varies according to the kind of scale. The narrow range accuracy refers to the accuracy determined by measuring one pitch of each grating at the limit of resolution (1µm for example).

## ■ Principle of the Absolute Linear Scale (Example: AT300, 500-S/H)

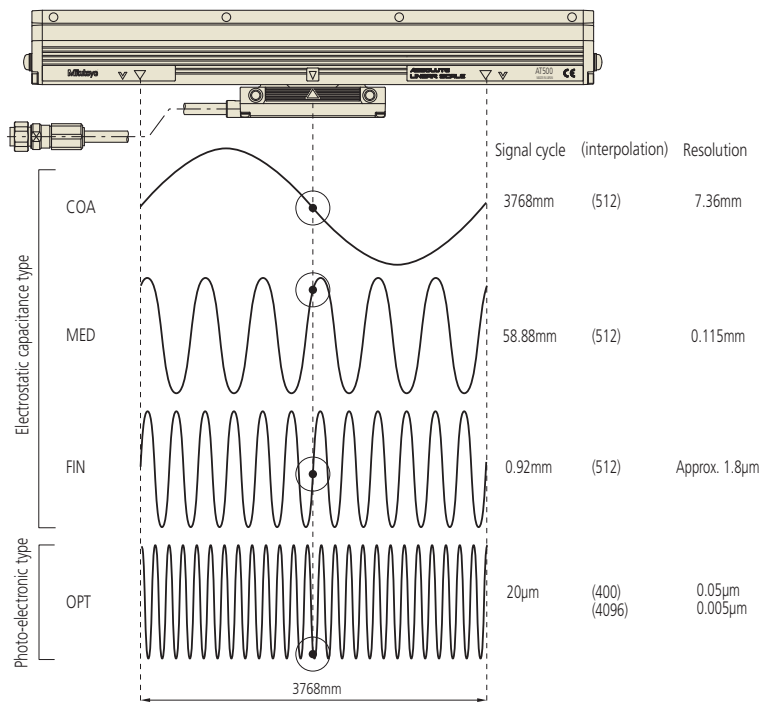

Upon supply of power to a linear scale, position readings from three capacitance-type sub-scales (COarse, MEDium and FINE) and one from a photoelectric sub-scale (OPTical) are taken. These sub-scales use such a combination of pitches, and are so positioned relative to each other, that the readings at any one position form a unique set and allow a microprocessor to calculate the position of the read head on the scale to a resolution of 0.05µm (0.005µm).

## ■ Specifying Linear Scale Accuracy

### Positional Indication accuracy

The accuracy of a linear scale is determined by comparing the positional value indicated by the linear scale with the corresponding value from a laser length measuring machine at regular intervals using the accuracy inspection system as shown in the figure below. As the temperature of the inspection environment is 20°C, the accuracy of the scale applies only in an environment at this temperature. Other inspection temperatures may be used to comply with internal standards.

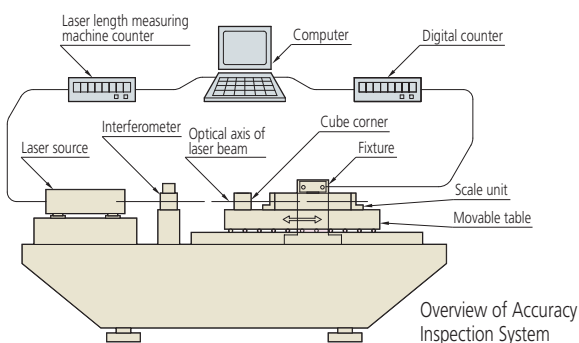

The accuracy of the scale at each point is defined in terms of an error value that is calculated using the following formula:

$$\text{Error} = \text{Value indicated by the linear scale} - \text{corresponding value of laser inspection system}$$

A graph in which the error at each point in the effective positioning range is plotted is called an accuracy diagram.

There are two methods used to specify the accuracy of a scale, unbalanced or balanced, described below.

### (1) Unbalanced accuracy specification - maximum minus minimum error

This method simply specifies the maximum error minus the minimum error from the accuracy graph, as shown below. It is of the form:  $E = (\alpha + \beta L)\mu\text{m}$ .  $L$  is the effective measuring range (mm), and  $\alpha$  and  $\beta$  are factors specified for each model.

For example, if a particular type of scale has an accuracy specification of  $(3 + \frac{3L}{1000})\mu\text{m}$  and an effective measuring range of 1000mm,  $E$  is 6µm.

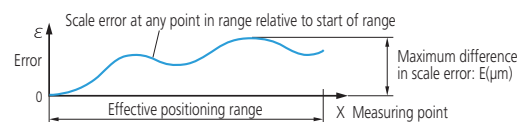

### (2) Balanced accuracy specification - plus and minus about the mean error

This method specifies the maximum error relative to the mean error from the accuracy graph. It is of the form:  $e = \pm \frac{E}{2} (\mu\text{m})$ . This is mainly used in separate-type (retrofit) scale unit specifications.

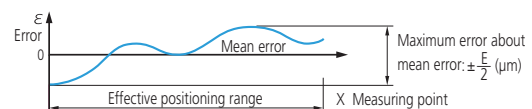

A linear scale detects displacement based on graduations of constant pitch. Two-phase sine wave signals with the same pitch as the graduations are obtained by detecting the graduations. Interpolating these signals in the electrical circuit makes it possible to read a value smaller than the graduations by generating pulse signals that correspond to the desired resolution. For example, if the graduation pitch is 20µm, interpolated values can generate a resolution of 1µm. The accuracy of this processing is not error-free and is called interpolation accuracy. The linear scale's overall positional accuracy specification depends both on the pitch error of the graduations and interpolation accuracy.

# Linear Scales

## Image correlation and the MICSYS two-dimensional encoder

### Principle of measurement

When a rough-surfaced object is irradiated with a laser beam, reflected coherent light scattering from the surface creates visible interference in the form of a speckle pattern. As the object moves in the xy plane, the speckle pattern also moves in response. Displacement of the object can be calculated by comparing, through image correlation, the speckle images obtained before and after movement, and this is the principle used in the highly accurate MICSYS measuring system.

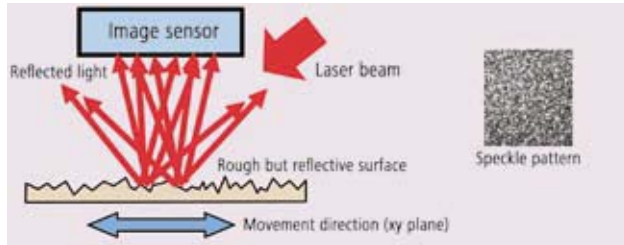

### Applications

#### 1. Evaluation of stages used in manufacturing equipment and inspection systems

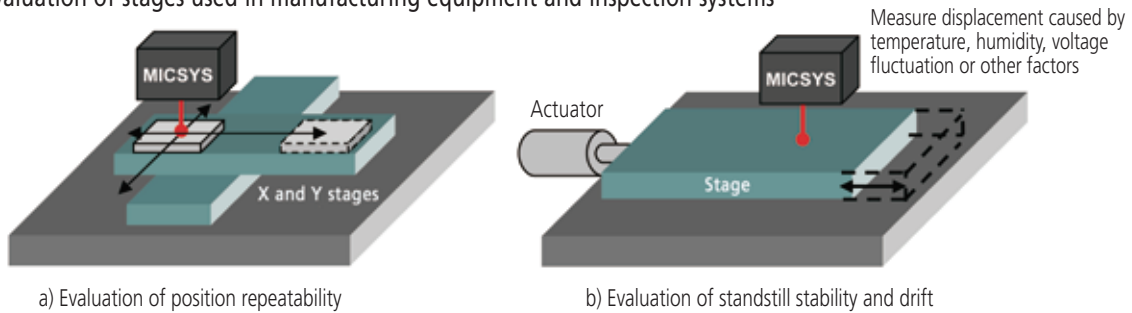

#### 2. Highly accurate positioning of workpieces

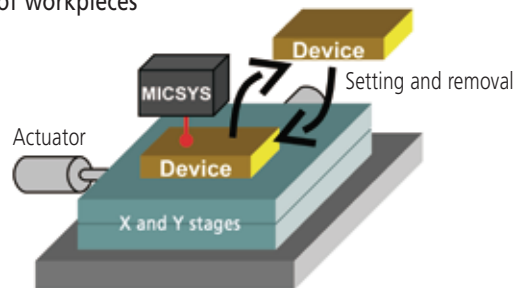

#### 3. Measurement of minute displacement

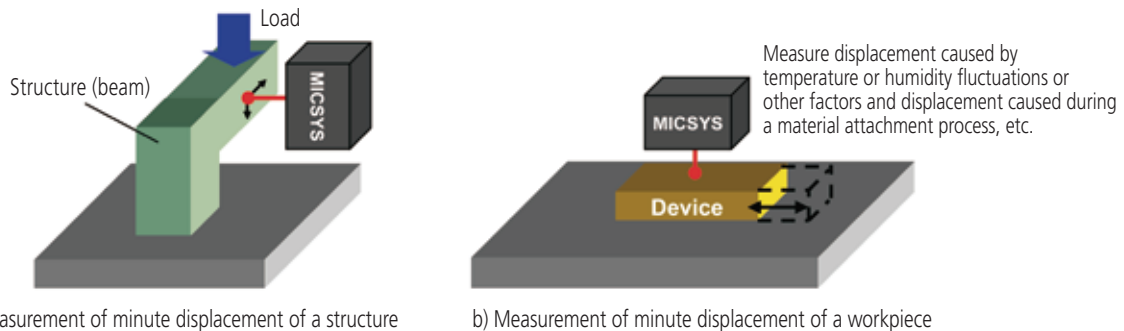

# Profile Projectors

## Erect Image and Inverted Image

An image of an object projected onto a screen is erect if it is orientated the same way as the object on the stage. If the image is reversed top to bottom, left to right and by movement with respect to the object on the stage (as shown in the figure below) it is referred to as an inverted image (also known as a reversed image, which is probably more accurate).

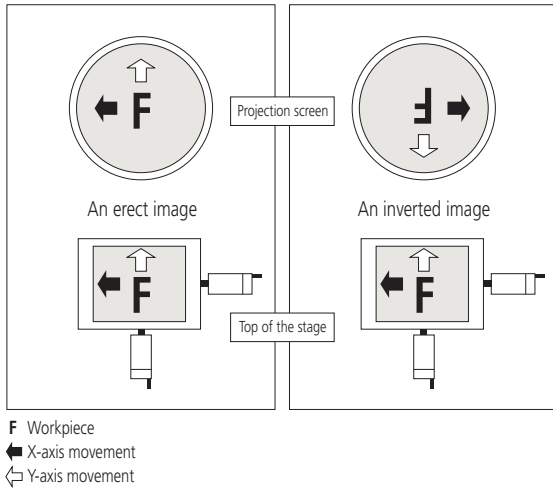

## Magnification Accuracy

The magnification accuracy of a projector when using a certain lens is established by projecting an image of a reference object and comparing the size of the image of this object, as measured on the screen, with the expected size (calculated from the lens magnification, as marked) to produce a percentage magnification accuracy figure, as illustrated below. The reference object is often in the form of a small, graduated glass scale called a 'stage micrometer' or 'standard scale', and the projected image of this is measured with a larger glass scale known as a 'reading scale'.

(Note that magnification accuracy is not the same as measuring accuracy.)

$$\Delta M(\%) = \frac{L - \ell M}{\ell M} \times 100$$

- $\Delta M(\%)$ : Magnification accuracy expressed as a percentage of the nominal lens magnification
- L: Length of the projected image of the reference object measured on the screen
- $\ell$ : Length of the reference object
- M: Magnification of the projection lens

## Type of Illumination

- **Contour illumination:** An illumination method to observe a workpiece by transmitted light and is used mainly for measuring the magnified contour image of a workpiece.
- **Coaxial surface illumination:** An illumination method whereby a workpiece is illuminated by light transmitted coaxially to the lens for the observation/measurement of the surface. (A half-mirror or a projection lens with a built-in half-mirror is needed.)
- **Oblique surface illumination:** A method of illumination by obliquely illuminating the workpiece surface. This method provides an image of enhanced contrast, allowing it to be observed three-dimensionally and clearly. However, note that an error is apt to occur in dimensional measurement with this method of illumination. (An oblique mirror is needed. Models in the PJ-H30 series are supplied with an oblique mirror.)

## Telecentric Optical System

An optical system based on the principle that the principal ray is aligned parallel to the optical axis by placing a lens stop on the focal point on the image side. Its functional feature is that the image will not vary in size though the image blurs as the object is shifted along the optical axis.

For measuring projectors and measuring microscopes, an identical effect is obtained by placing a lamp filament at the focal point of a condenser lens instead of a lens stop so that the object is illuminated with parallel beams. (See the figure below.)

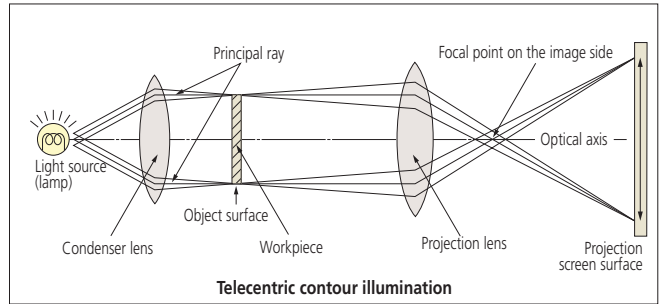

## Working distance

Refers to the distance from the face of the projection lens to the surface of a workpiece in focus. It is represented by L in the diagram below.

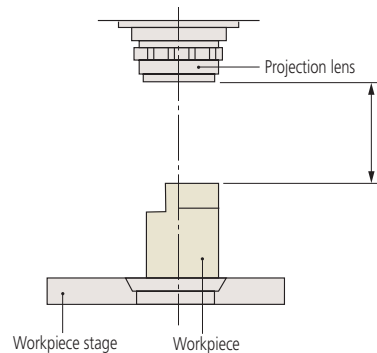

## Parallax error

This is the displacement of an object against a fixed background caused by a change in the observer's position and a finite separation of the object and background planes.

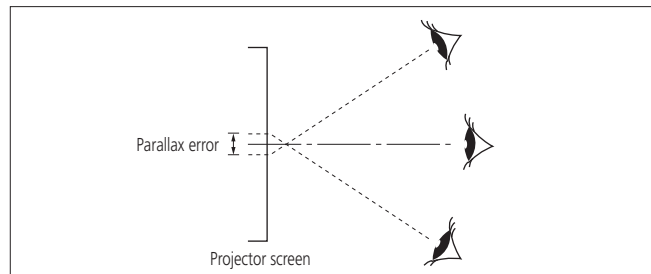

## Field of view diameter

The maximum diameter of workpiece that can be projected using a particular lens.

$$\text{Field of view diameter (mm)} = \frac{\text{Screen diameter of profile projector}}{\text{Magnification of projection lens used}}$$

Example: If a 5X magnification lens is used for a projector with a screen of  $\varnothing 500\text{mm}$ :

$$\text{Field of view diameter is given by } \frac{500\text{mm}}{5} = 100\text{mm}$$

# Microscopes

## Numerical Aperture (NA)

The NA figure is important because it indicates the resolving power of an objective lens. The larger the NA value the finer the detail that can be seen. A lens with a larger NA also collects more light and will normally provide a brighter image with a narrower depth of focus than one with a smaller NA value.

$$NA = n \cdot \sin\theta$$

The formula above shows that NA depends on  $n$ , the refractive index of the medium that exists between the front of an objective and the specimen (for air,  $n=1.0$ ), and angle  $\theta$ , which is the half-angle of the maximum cone of light that can enter the lens.

## Resolving Power (R)

The minimum detectable distance between two image points, representing the limit of resolution. Resolving power (R) is determined by numerical aperture (NA) and wavelength ( $\lambda$ ) of the illumination.

$$R = \frac{\lambda}{2 \cdot NA} \text{ (}\mu\text{m)}$$

$\lambda = 0.55\mu\text{m}$  is often used as the reference wavelength

## Working Distance (W.D.)

The distance between the front end of a microscope objective and the surface of the workpiece at which the sharpest focusing is obtained.

## Parfocal Distance

The distance between the mounting position of a microscope objective and the surface of the workpiece at which the sharpest focusing is obtained. Objective lenses mounted together in the same turret should have the same parfocal distance so that when another objective is brought into use the amount of refocussing needed is minimal.

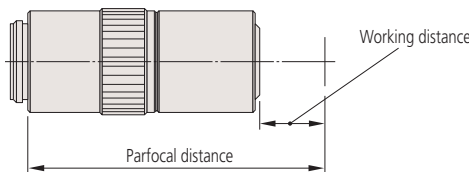

## Infinity Optical System

An optical system where the objective forms its image at infinity and a tube lens is placed within the body tube between the objective and the eyepiece to produce the intermediate image. After passing through the objective the light effectively travels parallel to the optical axis to the tube lens through what is termed the 'infinity space' within which auxiliary components can be placed, such as differential interference contrast (DIC) prisms, polarizers, etc., with minimal effect on focus and aberration corrections.

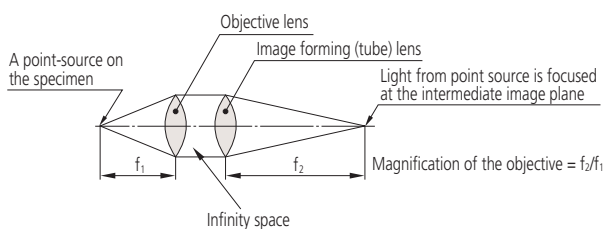

## Finite Optical System

An optical system that uses an objective to form the intermediate image at a finite position. Light from the workpiece passing through the objective is directed toward the intermediate image plane (located at the front focal plane of the eyepiece) and converges in that plane.

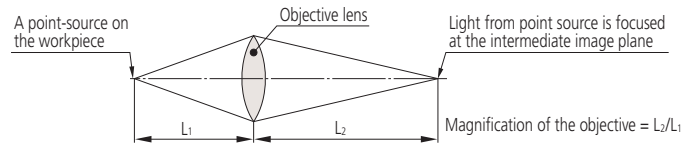

## Focal Length (f)

unit: mm

The distance from the principal point to the focal point of a lens: if  $f_1$  represents the focal length of an objective and  $f_2$  represents the focal length of an image forming (tube) lens then magnification is determined by the ratio between the two. (In the case of the infinity-correction optical system.)

$$\text{Objective magnification} = \frac{\text{Focal length of the image-forming (tube) lens}}{\text{Focal length of the objective}}$$

$$\text{Example: } 1X = \frac{200}{200} \quad \text{Example: } 10X = \frac{200}{20}$$

## Focal Point

Light rays traveling parallel to the optical axis of a converging lens system and passing through that system will converge (or focus) to a point on the axis known as the rear focal point, or image focal point.

## Depth of Focus (DOF)

unit: mm

Also known as 'depth of field', this is the distance (measured in the direction of the optical axis) between the two planes which define the limits of acceptable image sharpness when the microscope is focused on an object. As the numerical aperture (NA) increases, the depth of focus becomes shallower, as shown by the expression below:

$$DOF = \frac{\lambda}{2 \cdot (NA)^2} \quad \lambda = 0.55\mu\text{m} \text{ is often used as the reference wavelength}$$

Example: For an **M Plan Apo 100X** lens ( $NA = 0.7$ )

The depth of focus of this objective is

$$\frac{0.55\mu\text{m}}{2 \times 0.7^2} = 0.6\mu\text{m}$$

## Bright-field Illumination and Dark-field Illumination

In brightfield illumination a full cone of light is focused by the objective on the specimen surface. This is the normal mode of viewing with an optical microscope. With darkfield illumination, the inner area of the light cone is blocked so that the surface is only illuminated by light from an oblique angle. Darkfield illumination is good for detecting surface scratches and contamination.

## Apochromat Objective and Achromat Objective

An apochromat objective is a lens corrected for chromatic aberration (color blur) in three colors (red, blue, yellow).

An achromat objective is a lens corrected for chromatic aberration in two colors (red, blue).

## ■ Magnification

The ratio of the size of a magnified object image created by an optical system to that of the object. Magnification commonly refers to lateral magnification although it can mean lateral, vertical, or angular magnification.

## ■ Principal Ray

A ray considered to be emitted from an object point off the optical axis and passing through the center of an aperture diaphragm in a lens system.

## ■ Aperture Diaphragm

An adjustable circular aperture which controls the amount of light passing through a lens system. It is also referred to as an aperture stop and its size affects image brightness and depth of focus.

## ■ Field Stop

A stop which controls the field of view in an optical instrument.

## ■ Telecentric System

An optical system where the light rays are parallel to the optical axis in object and/or image space. This means that magnification is nearly constant over a range of working distances, therefore almost eliminating perspective error.

## ■ Erect Image

An image in which the orientations of left, right, top, bottom and moving directions are the same as those of a workpiece on the workstage.

## ■ Field number (FN), real field of view, and monitor display magnification

unit: mm

The observation range of the sample surface is determined by the diameter of the eyepiece's field stop. The value of this diameter in millimeters is called the field number (FN). In contrast, the real field of view is the range on the workpiece surface when actually magnified and observed with the objective lens.

The real field of view can be calculated with the following formula:

### (1) The range of the workpiece that can be observed with the microscope (diameter)

$$\text{Real field of view} = \frac{\text{FN of eyepiece}}{\text{Objective lens magnification}}$$

Example: The real field of view of a 1X lens is  $24 = \frac{24}{1}$   
 The real field of view of a 10X lens is  $2.4 = \frac{24}{10}$

### (2) Monitor observation range

$$\text{Monitor observation range} = \frac{\text{The size of the camera image sensor (diagonal length)}}{\text{Objective lens magnification}}$$

#### ● Size of image sensor

Format	Diagonal length	Length	Height
1/3"	6.0	4.8	3.6
1/2"	8.0	6.4	4.8
2/3"	11.0	8.8	6.6

### (3) Monitor display magnification

$$\text{Monitor display magnification} = \text{Objective lens magnification} \times \frac{\text{Display diagonal length on the monitor}}{\text{Diagonal length of camera image sensor}}$$

# Vision Measuring Machines

## ■ Vision Measurement

Vision measuring machines mainly provide the following processing capabilities.

### ■ Edge detection

Detecting/measuring edges in the XY plane

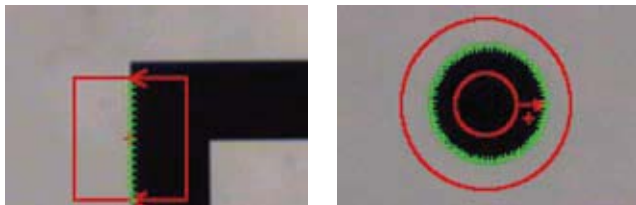

### ■ Auto focusing

Focusing and Z measurement

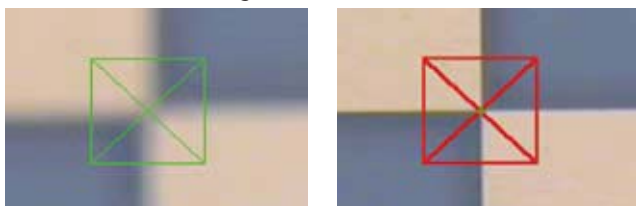

### ■ Pattern recognition

Alignment, positioning, and checking a feature

## ■ Image Storage

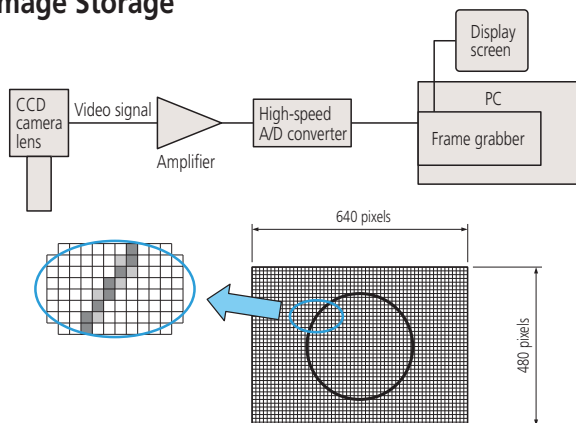

An image is comprised of a regular array of pixels. This is just like a picture on fine plotting paper with each square solid-filled differently.

## ■ Gray Scale

A PC stores an image after internally converting it to numeric values. A numeric value is assigned to each pixel of an image. Image quality varies depending on how many levels of gray scale are defined by the numeric values. The PC provides two types of gray scale: two-level and multi-level. The pixels in an image are usually displayed as 256-level gray scale.

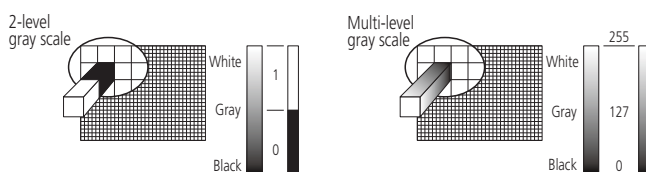

Pixels in an image brighter than a given level are displayed as white and all other pixels are displayed as black.

Each pixel is displayed as one of 256 levels between black and white. This allows high-fidelity images to be displayed.

## ■ Difference in Image Quality

Difference between 2-level and 256-level gray-scale images

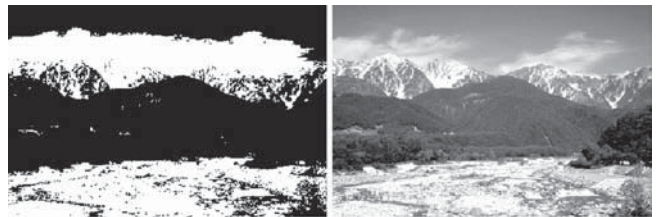

Sample image displayed in 2-level gray scale

Sample image displayed in 256-level gray scale

## ■ Variation in Image Depending on Threshold Level



These three pictures are the same image displayed as 2-level gray scale at different slice levels (threshold levels). In a 2-level gray-scale image, different images are provided as shown above due to a difference in slice level. Therefore, the 2-level gray scale is not used for high-precision vision measurement since numeric values will change depending on the threshold level that is set.

## ■ Dimensional Measurement

An image consists of pixels. If the number of pixels in a section to be measured is counted and is multiplied by the size of a pixel, then the section can be converted to a numeric value in length. For example, assume that the total number of pixels in the lateral size of a square workpiece is 300 pixels as shown in the figure below. If a pixel size is 10µm under imaging magnification, the total length of the workpiece is given by 10µm x 300 pixels = 3000µm = 3mm.

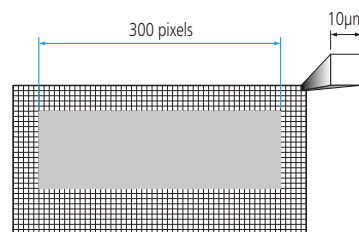

## ■ Edge Detection

How to actually detect a workpiece edge in an image is described using the following monochrome picture as an example. Edge detection is performed within a given domain. A symbol which visually defines this domain is referred to as a tool. Multiple tools are provided to suit various workpiece geometries or measurement data.

244	241	220	193	97	76	67	52	53	53
243	242	220	195	94	73	66	54	53	55
244	246	220	195	94	75	64	56	51	50

Example of numeric values assigned to pixels on the tool

(1) Scan start position  
(2) Edge detection position  
(3) Scan end position



## High-resolution Measurement

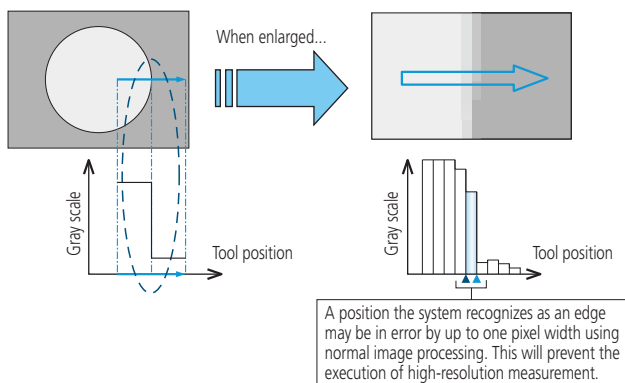

To increase the accuracy in edge detection, sub-pixel image processing is used.

An edge is detected by determining interpolation curve from adjacent pixel data as shown below. As a result, it allows measurement with a resolution higher than 1 pixel.

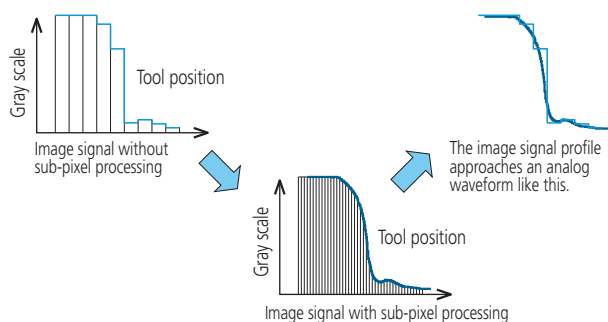

## Measurement along Multiple Portions of an Image

Large features that cannot be contained on one screen have to be measured by precisely controlling the position of the CCD sensor and stage so as to locate each reference point within individual images. By this means the system can measure even a large circle, as shown below, by detecting the edge while moving the stage across various parts of the periphery.

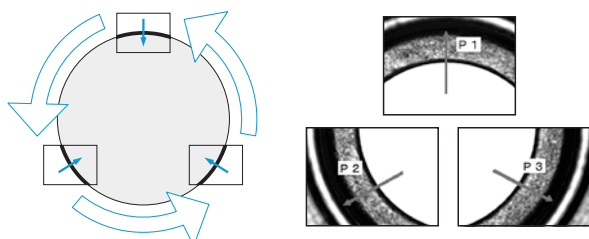

## Composite Coordinates of a Point

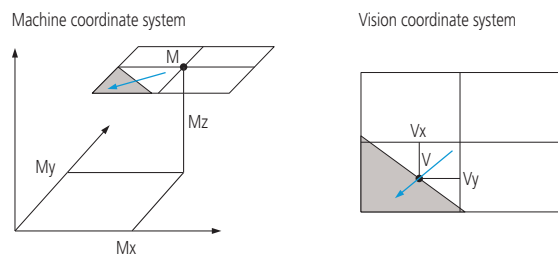

Measuring machine stage position

$$M = (M_x, M_y, M_z)$$

Detected edge position (from the center of vision)

$$V = (V_x, V_y)$$

Actual coordinates are given by  $X = (M_x + V_x)$ ,  $Y = (M_y + V_y)$ , and  $Z = M_z$ , respectively.

Since measurement is performed while individual measured positions are stored, the system can measure dimensions that cannot be included in one screen, without problems.

## Principle of Auto Focusing

The system can perform XY-plane measurement, but cannot perform height measurement using only the CCD camera image. The system is commonly provided with the Auto Focus (AF) mechanism for height measurement. The following explains the AF mechanism that uses a common image, although some systems may use an AF laser.

The AF system analyzes an image while moving the CCD up and down in the Z axis. In the analysis of image contrast, an image in sharp focus will show a peak contrast and one out of focus will show a low contrast. Therefore, the height at which the image contrast peaks is the just-in-focus height.

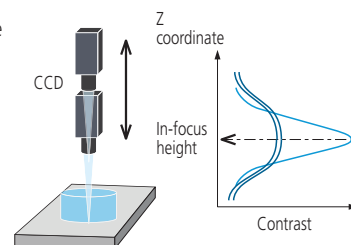

## Variation in Contrast Depending on the Focus Condition

Edge contrast is low due to out-of-focus edges.

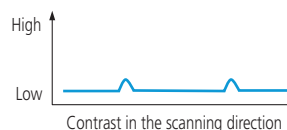

Edge contrast is high due to sharp, in-focus edges.

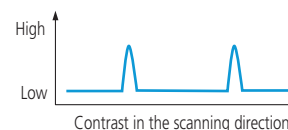

# Surftest (Surface Roughness Testers)

- ISO 1302: 2002 Notation method of surface texture
- ISO 4287: 1997 Geometrical Product Specifications (GPS) –Surface Texture: Profile method– Terms, definitions, and surface texture parameters
- ISO 4288: 1996 Geometrical Product Specifications (GPS) –Surface Texture: Profile method– Rules and procedures for the assessment of surface texture
- ISO 3274: 1996 Geometrical Product Specifications (GPS) –Surface Texture: Profile method– Nominal characteristics of contact (stylus) instruments

## Elements of Contact Type Surface Roughness Measuring Instruments

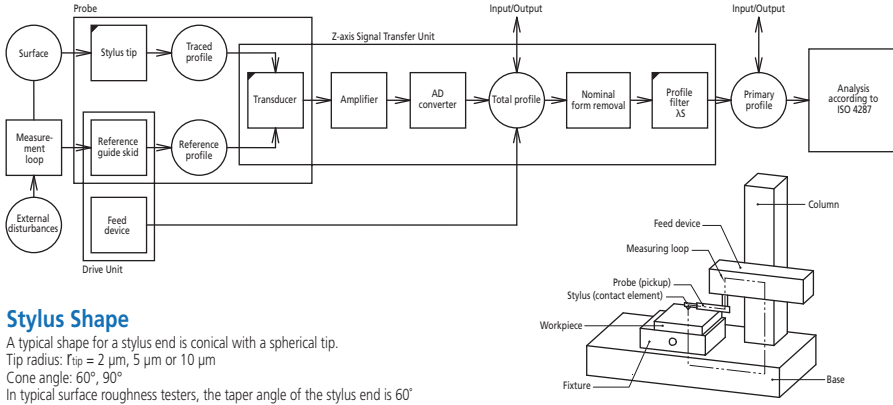

### Stylus Shape

A typical shape for a stylus end is conical with a spherical tip.  
 Tip radius:  $r_{tip} = 2 \mu\text{m}, 5 \mu\text{m}$  or  $10 \mu\text{m}$   
 Cone angle:  $60^\circ, 90^\circ$   
 In typical surface roughness testers, the taper angle of the stylus end is  $60^\circ$  unless otherwise specified.

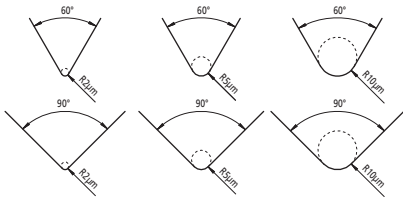

### Static Measuring Force (JIS B 0651)

Nominal radius of curvature of stylus tip: $\mu\text{m}$	Static measuring force at the mean position of stylus: mN	Tolerance on static measuring force variations: mN/ $\mu\text{m}$
2	0.75	0.035
5	0.75 (4.0) Note 1	0.2
10		

Note 1: The maximum value of static measuring force at the average position of a stylus is to be 4.0mN for a special structured probe including a replaceable stylus.

## Metrological Characterization of Phase Correct Filters

A profile filter is a phase-correct filter without phase delay (cause of profile distortion dependent on wavelength). The weight function of a phase-correct filter shows a normal (Gaussian) distribution in which the amplitude transmission is 50% at the cutoff wavelength.

ISO 11562: 1996  
 (JIS B 0632: 2001)

## Data Processing Flow

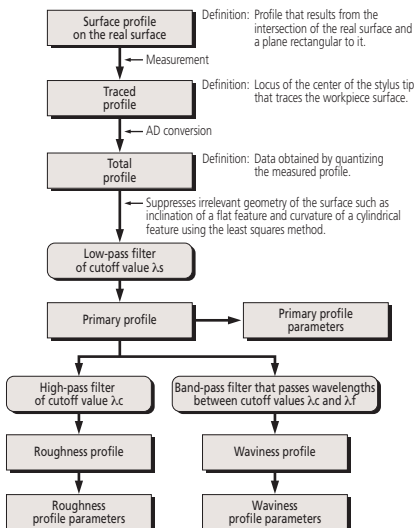

## Relationship between Cutoff Value and Stylus Tip Radius

The following table lists the relationship between the roughness profile cutoff value  $\lambda_c$ , stylus tip radius  $r_{tip}$ , and cutoff ratio  $\lambda_c/r_{tip}$ .

$\lambda_c$ mm	$\lambda_s$ $\mu\text{m}$	$\lambda_c/\lambda_s$	Maximum $r_{tip}$ $\mu\text{m}$	Maximum sampling length $\mu\text{m}$
0.08	2.5	30	2	0.5
0.25	2.5	100	2	0.5
0.8	2.5	300	2 Note 1	0.5
2.5	8	300	5 Note 2	1.5
8	25	300	10 Note 2	5

Note 1: For a surface with  $R_a > 0.5 \mu\text{m}$  or  $R_z > 3 \mu\text{m}$ , a significant error will not usually occur in a measurement even if  $r_{tip} = 5 \mu\text{m}$ .  
 Note 2: If a cutoff value  $\lambda_s$  is  $2.5 \mu\text{m}$  or  $8 \mu\text{m}$ , attenuation of the signal due to the mechanical filtering effect of a stylus with the recommended tip radius appears outside the roughness profile pass band. Therefore, a small error in stylus tip radius or shape does not affect parameter values calculated from measurements. If a specific cutoff ratio is required, the ratio must be defined.

## Surface Profiles

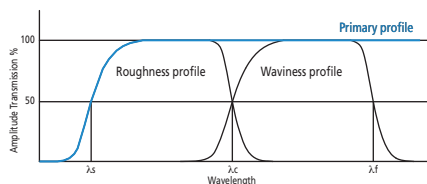

### Primary Profile

Profile obtained from the measured profile by applying a low-pass filter with cutoff value  $\lambda_s$ .

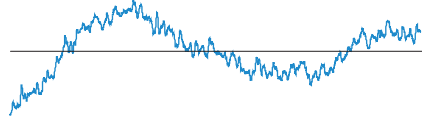

### Roughness Profile

Profile obtained from the primary profile by suppressing the longer wavelength components using a high-pass filter of cutoff value  $\lambda_c$ .



### Waviness Profile

Profile obtained by applying a band-pass filter to the primary profile to remove the longer wavelengths above  $\lambda_f$  and the shorter wavelengths below  $\lambda_c$ .

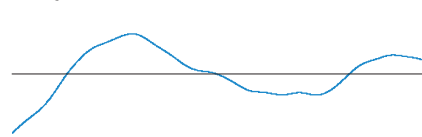

## Definition of Parameters

ISO 4287: 1997

### Amplitude Parameters (peak and valley)

Maximum peak height of the primary profile  $P_p$   
 Maximum peak height of the roughness profile  $R_p$   
 Maximum peak height of the waviness profile  $W_p$   
 Largest profile peak height  $Z_p$  within a sampling length

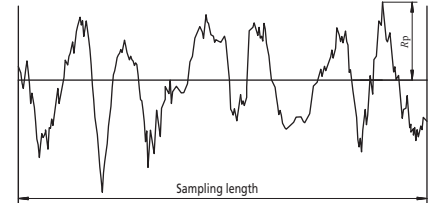

Maximum valley depth of the primary profile  $P_v$   
 Maximum valley depth of the roughness profile  $R_v$   
 Maximum valley depth of the waviness profile  $W_v$   
 Largest profile valley depth  $Z_v$  within a sampling length

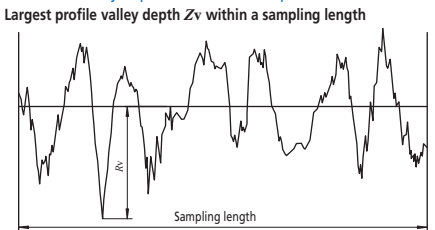

### Sum of height of the largest profile peak height $Z_p$ and the largest profile valley depth $Z_v$ within a sampling length

Maximum height of the primary profile  $P_z$   
 Maximum height of the roughness profile  $R_z$   
 Maximum height of the waviness profile  $W_z$

Sum of height of the largest profile peak height  $Z_p$  and the largest profile valley depth  $Z_v$  within a sampling length

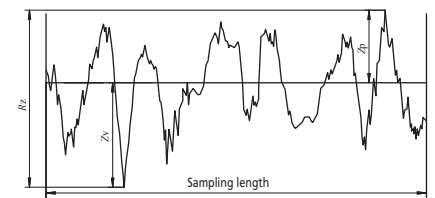

In Old JIS and ISO 4287-1: 1984,  $R_z$  was used to indicate the "ten point height of irregularities". Care must be taken because differences between results obtained according to the existing and old standards are not always negligibly small. (Be sure to check whether the drawing instructions conform to existing or old standards.)

### Mean height of the primary profile elements $P_c$

Mean height of the roughness profile elements  $R_c$

Mean height of the waviness profile elements  $W_c$

Mean value of the profile element heights  $Z_t$  within a sampling length

$$P_c, R_c, W_c = \frac{1}{m} \sum_{i=1}^m Z_i$$

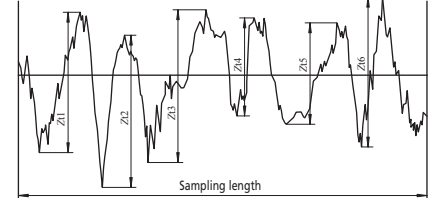

### Total height of the primary profile $P_t$

Total height of the roughness profile  $R_t$

Total height of the waviness profile  $W_t$

Sum of the height of the largest profile peak height  $Z_p$  and the largest profile valley depth  $Z_v$  within the evaluation length

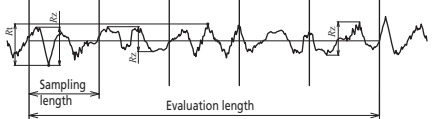

### Amplitude Parameters (average of ordinates)

Arithmetical mean deviation of the primary profile  $P_a$   
 Arithmetical mean deviation of the roughness profile  $R_a$   
 Arithmetical mean deviation of the waviness profile  $W_a$   
 Arithmetic mean of the absolute ordinate values  $Z(x)$  within a sampling length

$$P_a, R_a, W_a = \frac{1}{l} \int_0^l |Z(x)| dx$$

with  $l$  as  $l_p, l_r, \text{ or } l_w$  according to the case.

Root mean square deviation of the primary profile  $P_q$   
 Root mean square deviation of the roughness profile  $R_q$   
 Root mean square deviation of the waviness profile  $W_q$   
 Root mean square value of the ordinate values  $Z(x)$  within a sampling length

$$P_q, R_q, W_q = \sqrt{\frac{1}{l} \int_0^l Z^2(x) dx}$$

with  $l$  as  $l_p, l_r, \text{ or } l_w$  according to the case.

Skewness of the primary profile  $P_{sk}$   
 Skewness of the roughness profile  $R_{sk}$   
 Skewness of the waviness profile  $W_{sk}$

Quotient of the mean cube value of the ordinate values  $Z(x)$  and the cube of  $P_q, R_q, \text{ or } W_q$  respectively, within a sampling length

$$R_{sk} = \frac{1}{R_q^3} \left[ \frac{1}{l} \int_0^l Z^3(x) dx \right]$$

The above equation defines  $R_{sk}$ .  $P_{sk}$  and  $W_{sk}$  are defined in a similar manner.  $P_{sk}, R_{sk}, \text{ and } W_{sk}$  are measures of the asymmetry of the probability density function of the ordinate values.

Kurtosis of the primary profile  $P_{ku}$   
 Kurtosis of the roughness profile  $R_{ku}$   
 Kurtosis of the waviness profile  $W_{ku}$

Quotient of the mean quartic value of the ordinate values  $Z(x)$  and the fourth power of  $P_q, R_q, \text{ or } W_q$  respectively, within a sampling length

$$R_{ku} = \frac{1}{R_q^4} \left[ \frac{1}{l} \int_0^l Z^4(x) dx \right]$$

The above equation defines  $R_{ku}$ .  $P_{ku}$  and  $W_{ku}$  are defined in a similar manner.  $P_{ku}, R_{ku}, \text{ and } W_{ku}$  are measures of the sharpness of the probability density function of the ordinate values.

### Spacing Parameters

Mean width of the primary profile elements  $P_{Sm}$   
 Mean width of the roughness profile elements  $R_{Sm}$   
 Mean width of the waviness profile elements  $W_{Sm}$   
 Mean value of the profile element widths  $X_s$  within a sampling length

$$P_{Sm}, R_{Sm}, W_{Sm} = \frac{1}{m} \sum_{i=1}^m X_{si}$$

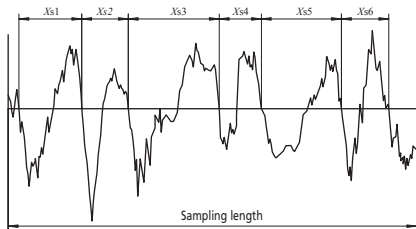

### Hybrid Parameters

Root mean square slope of the primary profile  $P_dq$   
 Root mean square slope of the roughness profile  $R_dq$   
 Root mean square slope of the waviness profile  $W_dq$   
 Root mean square value of the ordinate slopes  $dZ/dx$  within a sampling length

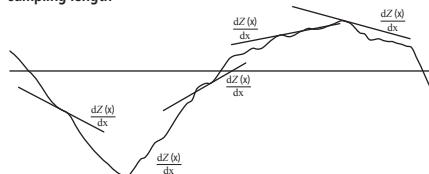

### Curves, Probability Density Function, and Related Parameters

Material ratio curve of the profile (Abbott-Firestone curve)  
 Curve representing the material ratio of the profile as a function of section level  $c$

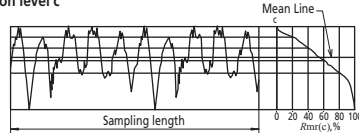

Material ratio of the primary profile  $P_{mr}(c)$   
 Material ratio of the roughness profile  $R_{mr}(c)$   
 Material ratio of the waviness profile  $W_{mr}(c)$

Ratio of the material length of the profile elements  $MI(c)$  at a given level  $c$  to the evaluation length

$$P_{mr}(c), R_{mr}(c), W_{mr}(c) = \frac{MI(c)}{ln}$$

Section height difference of the primary profile  $P_{\delta c}$   
 Section height difference of the roughness profile  $R_{\delta c}$   
 Section height difference of the waviness profile  $W_{\delta c}$

Vertical distance between two section levels of a given material ratio

$$R_{\delta c} = c(R_{mr1}) - c(R_{mr2}), R_{mr1} < R_{mr2}$$

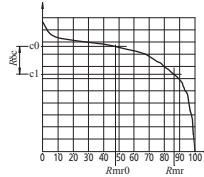

Relative material ratio of the primary profile  $P_{mr}$   
 Relative material ratio of the roughness profile  $R_{mr}$   
 Relative material ratio of the waviness profile  $W_{mr}$

Material ratio determined at a profile section level  $R_{\delta c}$  (or  $P_{\delta c}$  or  $W_{\delta c}$ ), related to the reference section level  $c_0$

$$P_{mr}, R_{mr}, W_{mr} = P_{mr}(c1), R_{mr}(c1), W_{mr}(c1)$$

where  $c1 = c0 - R_{\delta c} (R_{\delta c}, W_{\delta c})$   
 $c0 = c(P_{mr0}, R_{mr0}, W_{mr0})$

Probability density function (profile height amplitude distribution curve)

Sample probability density function of the ordinate  $Z(x)$  within the evaluation length

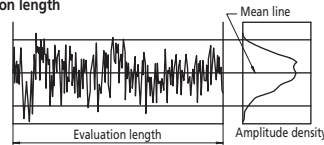

### JIS Specific Parameters

Ten-point height of irregularities,  $Rz_{jis}$   
 Sum of the absolute mean height of the five highest profile peaks and the absolute mean depth of the five deepest profile valleys, measured from the mean line within the sampling length of a roughness profile. This profile is obtained from the primary profile using a phase-correct band-pass filter with cutoff values of  $lc$  and  $ls$ .

$$Rz_{jis} = \frac{|Z_{p1} + Z_{p2} + Z_{p3} + Z_{p4} + Z_{p5}| + |Z_{v1} + Z_{v2} + Z_{v3} + Z_{v4} + Z_{v5}|}{5}$$

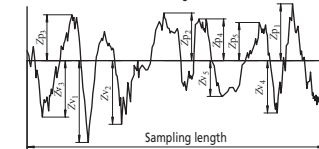

Symbol	Used profile
$Rz_{jis82}$	Surface profile as measured
$Rz_{jis94}$	Roughness profile derived from the primary profile using a phase-correct high-pass filter

### Arithmetic mean deviation of the profile $Ra_{75}$

Arithmetic mean of the absolute values of the profile deviations from the mean line within the sampling length of the roughness profile (75%). This profile is obtained from a measurement profile using an analog high-pass filter with an attenuation factor of 12db/octave and a cutoff value of  $\lambda_c$ .

$$Ra_{75} = \frac{1}{l} \int_0^l |Z(x)| dx$$

## Roughness sampling length for non-periodic profiles

ISO 4288: 1996 (JIS B 0633: 2001)

Table 1: Sampling lengths for aperiodic profile roughness parameters ( $R_a, R_q, R_{sk}, R_{ku}, R_dq$ ), material ratio curve, probability density function, and related parameters

$R_a$ $\mu m$	Sampling length $l_r$ mm	Evaluation length $l_n$ mm
(0.006) < $R_a$ $\leq$ 0.02	0.08	0.4
0.02 < $R_a$ $\leq$ 0.1	0.25	1.25
0.1 < $R_a$ $\leq$ 2	0.8	4
2 < $R_a$ $\leq$ 10	2.5	12.5
10 < $R_a$ $\leq$ 80	8	40

Table 2: Sampling lengths for aperiodic profile roughness parameters ( $R_z, R_v, R_p, R_c, R_t$ )

$R_z, R_z1_{max}$ $\mu m$	Sampling length $l_r$ mm	Evaluation length $l_n$ mm
(0.025) < $R_z, R_z1_{max}$ $\leq$ 0.1	0.08	0.4
0.1 < $R_z, R_z1_{max}$ $\leq$ 0.5	0.25	1.25
0.5 < $R_z, R_z1_{max}$ $\leq$ 10	0.8	4
10 < $R_z, R_z1_{max}$ $\leq$ 50	2.5	12.5
50 < $R_z, R_z1_{max}$ $\leq$ 200	8	40

1)  $R_z$  is used for measurement of  $R_z, R_v, R_p, R_c, \text{ and } R_t$ .  
 2)  $R_z1_{max}$  only used for measurement of  $R_z1_{max}, R_v1_{max}, R_p1_{max}, \text{ and } R_c1_{max}$ .

Table 3: Sampling lengths for measurement of periodic roughness profile roughness parameters and periodic or aperiodic profile parameter  $R_{Sm}$

$R_{Sm}$ mm	Sampling length $l_r$ mm	Evaluation length $l_n$ mm
0.013 < $R_{Sm}$ $\leq$ 0.04	0.08	0.4
0.04 < $R_{Sm}$ $\leq$ 0.13	0.25	1.25
0.13 < $R_{Sm}$ $\leq$ 0.4	0.8	4
0.4 < $R_{Sm}$ $\leq$ 1.3	2.5	12.5
1.3 < $R_{Sm}$ $\leq$ 4	8	40

## Procedure for determining a sampling length if it is not specified

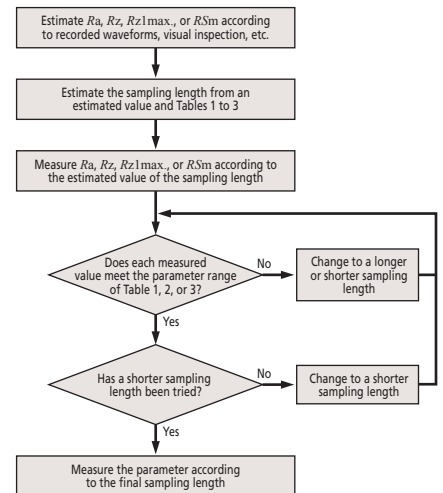

Fig.1 Procedure for determining the sampling length of an aperiodic profile if it is not specified.

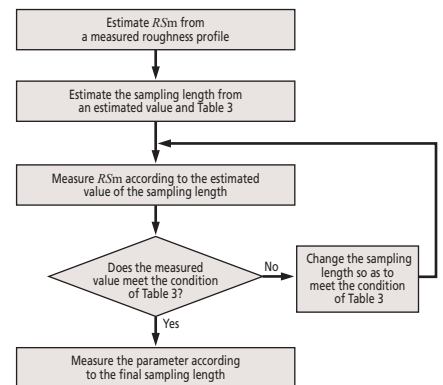
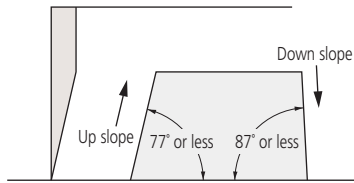

Fig.2 Procedure for determining the sampling length of a periodic profile if it is not specified.

# Contracer (Contour Measuring Instruments)

## Traceable Angle



The maximum angle at which a stylus can trace upwards or downwards along the contour of a workpiece, in the stylus travel direction, is referred to as the traceable angle. A one-sided sharp stylus with a tip angle of  $12^\circ$  (as in the above figure) can trace a maximum  $77^\circ$  of up slope and a maximum  $87^\circ$  of down slope. For a conical stylus ( $30^\circ$  cone), the traceable angle is smaller. An up slope with an angle of  $77^\circ$  or less overall may actually include an angle of more than  $77^\circ$  due to the effect of surface roughness. Surface roughness also affects the measuring force.

For model CV-3200/4500, the same type of stylus (SPH-71: one-sided sharp stylus with a tip angle of  $12^\circ$ ) can trace a maximum  $77^\circ$  of up slope and a maximum  $83^\circ$  of down slope.

## Compensating for Stylus Tip Radius

A recorded profile represents the locus of the center of the ball tip rolling on a workpiece surface. (A typical radius is 0.025mm.) Obviously this is not the same as the true surface profile so, in order to obtain an accurate profile record, it is necessary to compensate for the effect of the tip radius through data processing.

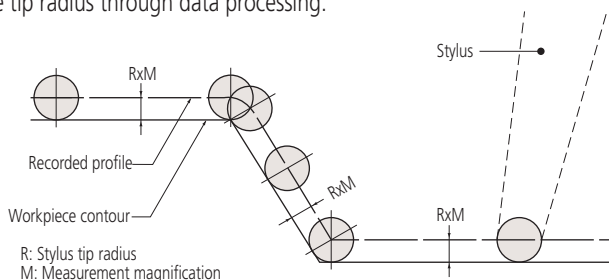

If a profile is read from the recorder through a template or scale, it is necessary to compensate for the stylus tip radius beforehand according to the applied measurement magnification.

## Compensating for Arm Rotation

The stylus is carried on a pivoted arm so it rotates as the surface is traced and the contact tip does not track purely in the Z direction. Therefore it is necessary to apply compensation in the X direction to ensure accuracy. There are three methods of compensating for arm rotation.

- 1: Mechanical compensation
- 2: Electrical compensation

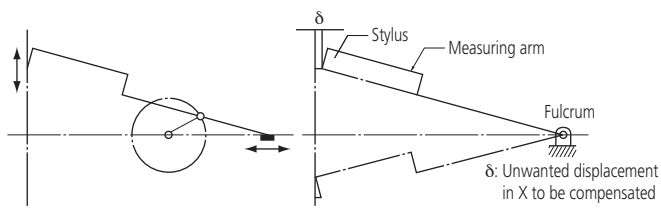

- 3: Software processing. To measure a workpiece contour that involves a large displacement in the vertical direction with high accuracy, one of these compensation methods needs to be implemented.

## Accuracy

As the detector units of the X and Z axes incorporate scales, the magnification accuracy is displayed not as a percentage but as the linear displacement accuracy for each axis.

## Overload Safety Cutout

If an excessive force (overload) is exerted on the stylus tip due, perhaps, to the tip encountering a too-steep slope on a workpiece feature, or a burr, etc., a safety device automatically stops operation and sounds an alarm buzzer. This type of instrument is commonly equipped with separate safety devices for the tracing direction (X axis) load and vertical direction (Y axis) load.

For model CV-3200/4500, a safety device functions if the arm comes off the detector mount.

## Simple or Complex Arm Guidance

In the case of a simple pivoted arm, the locus that the stylus tip traces during vertical movement (Z direction) is a circular arc that results in an unwanted offset in X, for which compensation has to be made. The larger the arc movement, the larger is the unwanted X displacement ( $\delta$ ) that has to be compensated. (See figure, lower left.) The alternative is to use a complex mechanical linkage arrangement to obtain a linear translation locus in Z, and therefore avoid the need to compensate in X.

## Z axis Measurement Methods

Though the X axis measurement method commonly adopted is by means of a digital scale, the Z axis measurement divides into analog methods (using a differential transformer, etc.) and digital scale methods.

Analog methods vary in Z axis resolution depending on the measurement magnification and measuring range. Digital scale methods have fixed resolution.

Generally, a digital scale method provides higher accuracy than an analog method.

## ■ Contour analysis methods

You can analyze the contour with one of the following two methods after completing the measurement operation.

### Data processing section and analysis program

The measured contour is input into the data processing section in real time and a dedicated program performs the analysis using the mouse and/or keyboard. The angle, radius, step, pitch and other data are directly displayed as numerical values. Analysis combining coordinate systems can be easily performed. The graph that goes through stylus radius correction is output to the printer as the recorded profile.

## ■ Tolerancing with Design Data

Measured workpiece contour data can be compared with design data in terms of actual and designed shapes rather than just analysis of individual dimensions. In this technique each deviation of the measured contour from the intended contour is displayed and recorded. Also, data from one workpiece example can be processed so as to become the master design data to which other workpieces are compared. This function is particularly useful when the shape of a section greatly affects product performance, or when its shape has an influence on the relationship between mating or assembled parts.

## ■ Best-fitting

If there is a standard for surface profile data, tolerancing with design data is performed according to the standard. If there is no standard, or if tolerancing only with shape is desired, best-fitting between design data and measurement data can be performed.

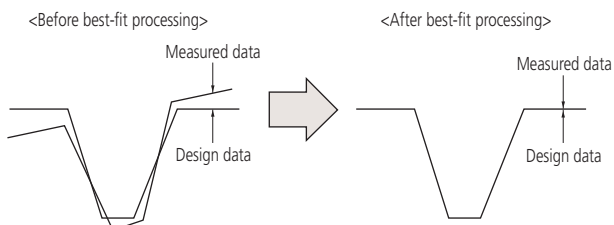

The best-fit processing algorithm searches for deviations between both sets of data and derives a coordinate system in which the sum of squares of the deviations is a minimum when the measured data is overlaid on the design data.

## ■ Data Combination

Conventionally, if tracing a complete contour is prevented by stylus traceable-angle restrictions then it has to be divided into several sections that are then measured and evaluated separately. This function avoids this undesirable situation by combining the separate sections into one contour by overlaying common elements (lines, points) onto each other. With this function the complete contour can be displayed and various analyses performed in the usual way.

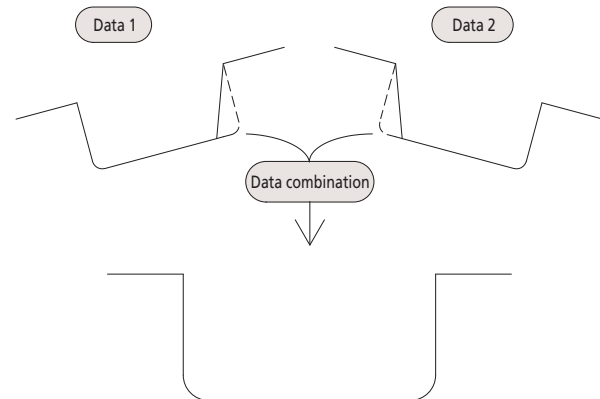

## ■ Measurement Examples



Aspheric lens contour



Inner/outer ring contour of a bearing



Internal gear teeth



Female thread form



Male thread form



Gage contour

# Roundtest (Roundform Measuring Instruments)

■ ISO 4291:1985 Methods for the assesement of departure from roundness -- Measurement of variations in radius

■ ISO 1101:2012 Geometrical product specifications (GPS) -- Geometrical tolerancing -- Tolerances of form, orientation, location and run-out

## ○ Roundness

Any circumferential line must be contained within the tolerance zone formed between two coplanar circles with a difference in radii of  $t$

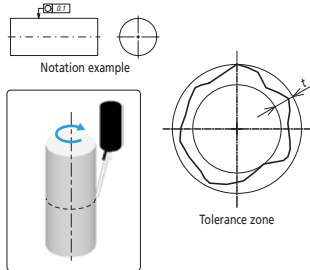

Verification example using a roundness measuring instrument

## — Straightness

Any line on the surface must lie within the tolerance zone formed between two parallel straight lines a distance  $t$  apart and in the direction specified

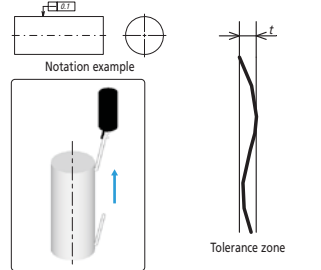

Verification example using a roundness measuring instrument

## □ Flatness

The surface must be contained within the tolerance zone formed between two parallel planes a distance  $t$  apart

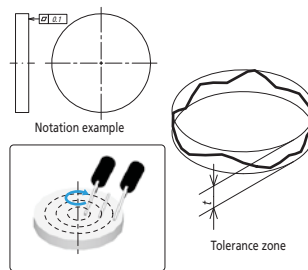

Verification example using a roundness measuring instrument

## ○/□ Cylindricity

The surface must be contained within the tolerance zone formed between two coaxial cylinders with a difference in radii of  $t$

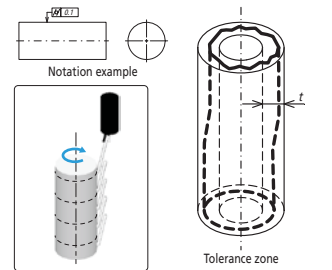

Verification example using a roundness measuring instrument

## ◎ Concentricity

The center point must be contained within the tolerance zone formed by a circle of diameter  $t$  concentric with the datum

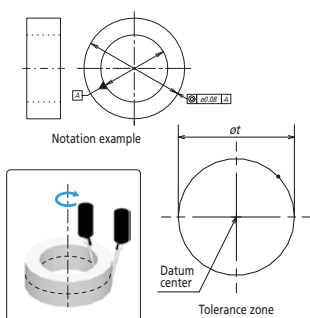

Verification example using a roundness measuring instrument

## ◎ Coaxiality

The axis must be contained within the tolerance zone formed by a cylinder of diameter  $t$  concentric with the datum

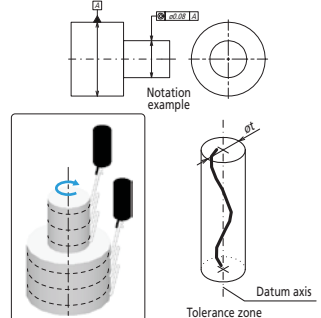

Verification example using a roundness measuring instrument

## ⊥ Perpendicularity

The line or surface must be contained within the tolerance zone formed between two planes a distance  $t$  apart and perpendicular to the datum

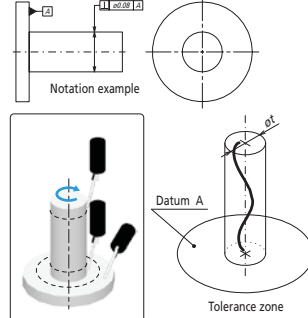

Verification example using a roundness measuring instrument

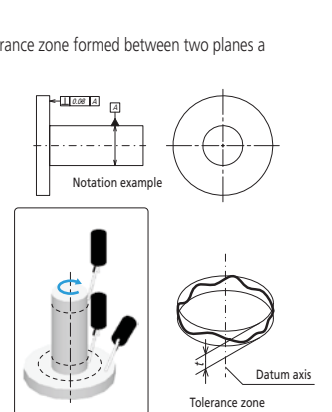

Verification example using a roundness measuring instrument

## ↗ Circular Runout (Radial and Axial)

The line must be contained within the tolerance zone formed between two coplanar and/or concentric circles a distance  $t$  apart concentric with or perpendicular to the datum

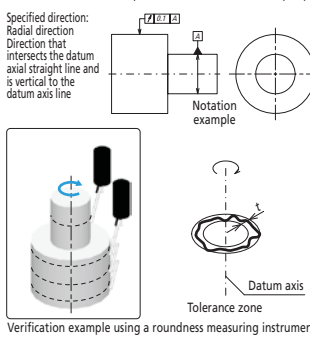

Verification example using a roundness measuring instrument

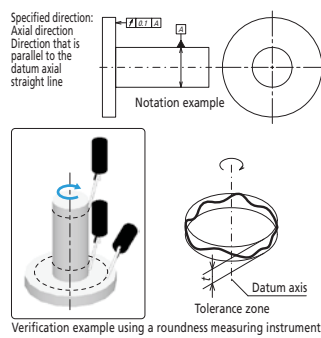

Verification example using a roundness measuring instrument

## ↗ Total Runout (Radial and Axial)

The surface must be contained within the tolerance zone formed between two coaxial cylinders with a difference in radii of  $t$ , or planes a distance  $t$  apart, concentric with or perpendicular to the datum

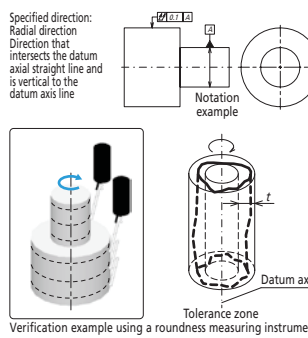

Verification example using a roundness measuring instrument

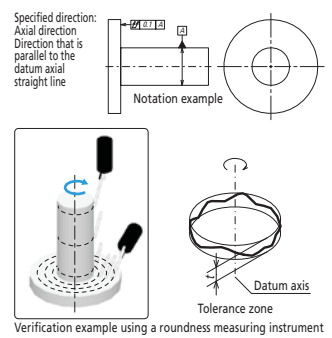

Verification example using a roundness measuring instrument

## ■ Adjustment prior to Measurement

### Centering

A displacement offset (eccentricity) between the Roundtest's rotary table axis and that of the workpiece results in distortion of the measured form (limaçon error) and consequently produces an error in the calculated roundness value. The larger the eccentricity, the larger is the error in calculated roundness. Therefore the workpiece should be centered (axes made coincident) before measurement. Some roundness testers support accurate measurement with a limaçon error correction function. The effectiveness of this function can be seen in the graph below.

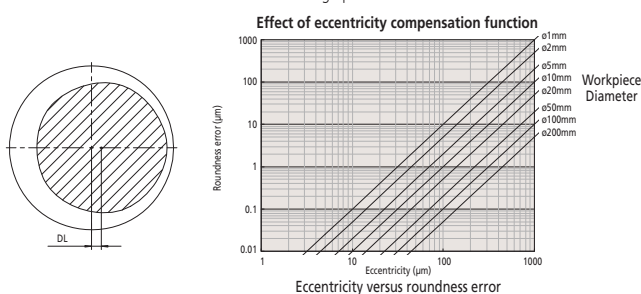

### Leveling

Any inclination of the axis of a workpiece with respect to the rotational axis of the measuring instrument will cause an elliptic error. Leveling must be performed so that these axes are sufficiently parallel.

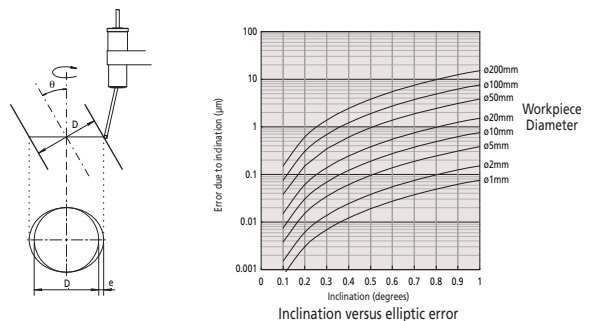

## Effect of Filter Settings on the Measured Profile

Profiles can be filtered in various ways to reduce or eliminate unwanted detail, with a cut-off value set in terms of undulations per revolution (upr). The effect of different upr settings is shown in the diagrams below, which illustrate how the measured roundness value decreases as lower upr settings progressively smooth out the line.

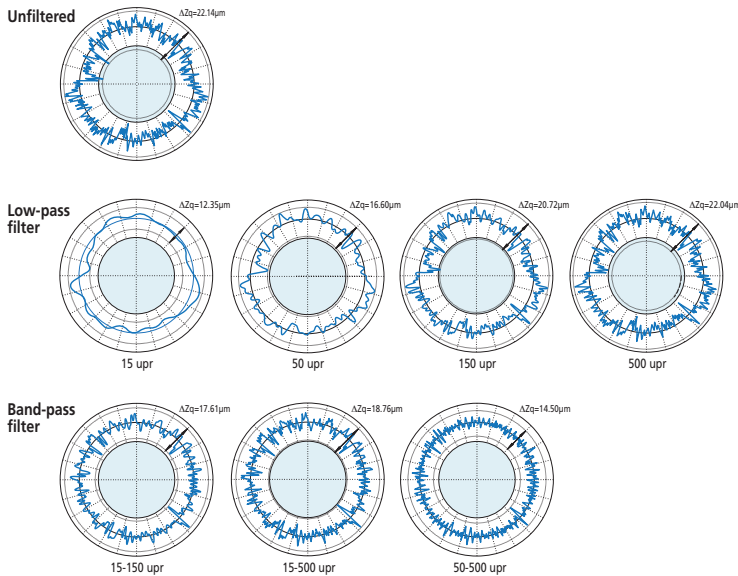

## Evaluating the Measured Profile Roundness

Roundness testers use the measurement data to generate reference circles whose dimensions define the roundness value. There are four methods of generating these circles, as shown below, and each method has individual characteristics so the method that best matches the function of the workpiece should be chosen. Each method results in a different center position for the reference circles and therefore affects the axial location of the circular feature measured.

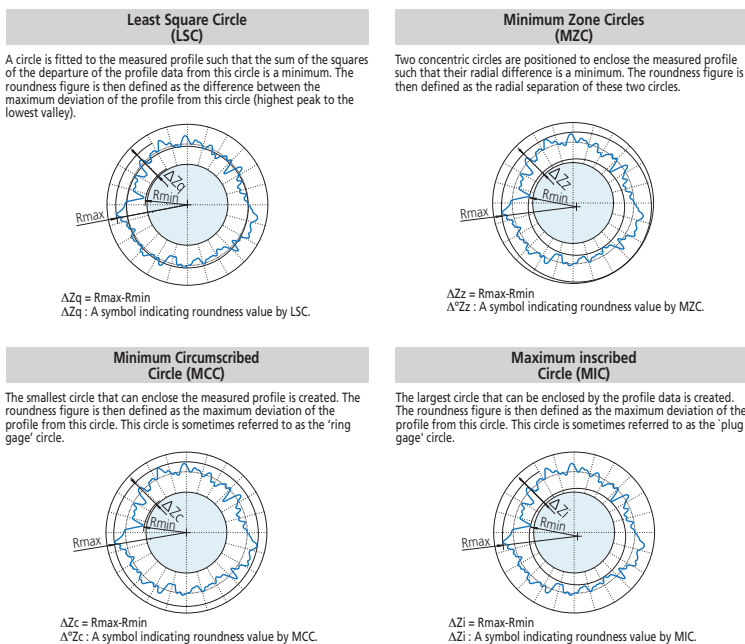

## Undulations Per Revolution (UPR) data in the roundness graphs

Measurement result graphs

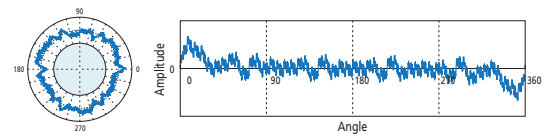

A 1 UPR condition indicates eccentricity of the workpiece relative to the rotational axis of the measuring instrument. The amplitude of undulation components depends on the leveling adjustment.

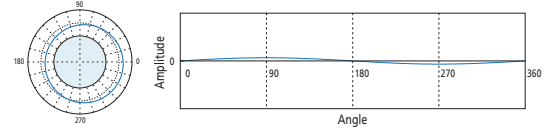

A 2 UPR condition may indicate: (1) insufficient leveling adjustment on the measuring instrument; (2) circular runout due to incorrect mounting of the workpiece on the machine tool that created its shape; (3) the form of the workpiece is elliptical by design as in, for example, an IC-engine piston.

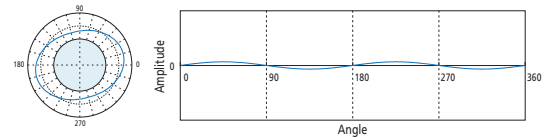

A 3 to 5 UPR condition may indicate: (1) Deformation due to over-tightening of the holding chuck on the measuring instrument; (2) Relaxation deformation due to stress release after unloading from the holding chuck on the machine tool that created its shape.

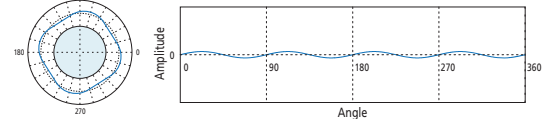
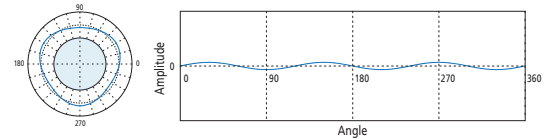

A 5 to 15 UPR condition often indicates unbalance factors in the machining method or processes used to produce the workpiece.

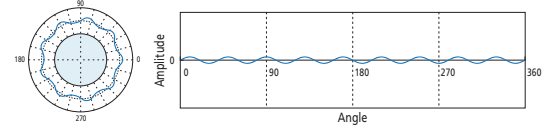
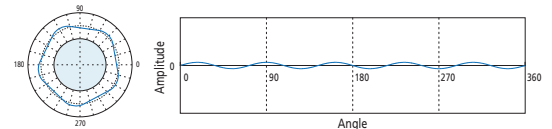

A 15 (or more) UPR condition is usually caused by tool chatter, machine vibration, coolant delivery effects, material non-homogeneity, etc., and is generally more important to the function than to the fit of a workpiece.

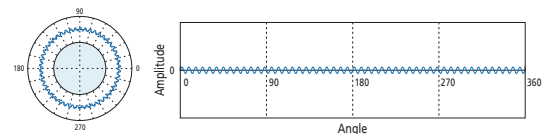
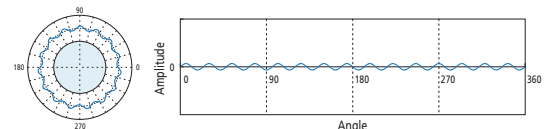

# Hardness Testing Machines

## ■ Hardness Test Methods and Guidelines for Selection of a Hardness Testing Machine

Test Method	Microhardness (Micro-Vickers)	Micro surface material characteristics	Vickers	Rockwell	Rockwell Superficial	Brinell	Shore	For sponge, rubber, and plastic	Rebound type portable
<b>Material</b>									
IC wafer	●	●							
Carbide, ceramics (cutting tool)		▲	●	●					
Steel (heat-treated material, raw material)	●	▲	●	●	●		●		●
Non-ferrous metal	●	▲	●	●	●				●
Plastic		▲		●				●	
Grinding stone				●					
Casting						●			
Sponge, rubber								●	
<b>Form</b>									
Thin metal sheet (safety razor, metal foil)	●	●	●		●				
Thin film, plating, painting, surface layer (nitrided layer)	●	●							
small parts, acicular parts (clock hand, sewing-machine needle)	●	▲							
Large specimen (structure)						●	●		●
Metallic material configuration (hardness for each phase of multilayer alloy)	●	●							
Plastic plate	▲	▲		●				●	
Sponge, rubber plate								●	
<b>Application</b>									
Strength or physical property of materials	●	●	●	●	●	●	●	●	▲
Heat treatment process	●		●	●	●		▲		▲
Carburized case depth	●		●						
Decarburized layer depth	●		●		●				
Flame or high-frequency hardening layer depth	●		●	●					
Hardenability test			●	●					
Maximum hardness of a welded spot			●						
Weld hardness			●	●					
High-temperature hardness (high-temperature characteristics, hot-workability)			●						
Fracture toughness (ceramics)	●		●						

Key: ● Well-suited ▲ Reasonably suited

## ■ Methods of Hardness Measurement

### (1) Vickers

Vickers hardness is a test method that has the widest application range, allowing hardness inspection with an arbitrary test force. This test has an extremely large number of application fields particularly for hardness tests conducted with a test force less than 9.807N (1kgf). As shown in the following formula, Vickers hardness is a value determined by dividing test force F (N) by contact area S (mm<sup>2</sup>) between a specimen and an indenter, which is calculated from diagonal length d (mm, mean of two directional lengths) of an indentation formed by the indenter (a square pyramidal diamond, opposing face angle θ=136°) in the specimen using a test force F (N). k is a constant (1/g=1/9.80665).

$$HV = k \frac{F}{S} = 0.102 \frac{F}{S} = 0.102 \frac{2F \sin \frac{\theta}{2}}{d^2} = 0.1891 \frac{F}{d^2}$$

F: N  
d: mm

The error in the calculated Vickers hardness is given by the following formula. Here, Δd1, Δd2, and 'a' represent the measurement error that is due to the microscope, an error in reading an indentation, and the length of an edge line generated by opposing faces of an indenter tip, respectively. The unit of Δθ is degrees.

$$\frac{\Delta HV}{HV} \approx \frac{\Delta F}{F} - 2 \frac{\Delta d1}{d} - 2 \frac{\Delta d2}{d} - \frac{a^2}{d^2} \cdot 3.5 \times 10^{-3} \Delta \theta$$

### (2) Knoop

As shown in the following formula, Knoop hardness is a value obtained by dividing test force by the projected area A (mm<sup>2</sup>) of an indentation, which is calculated from the longer diagonal length d (mm) of the indentation formed by pressing a rhomboidal diamond indenter (opposing edge angles of 172°30' and 130°) into a specimen with test force F applied. Knoop hardness can also be measured by replacing the Vickers indenter of a microhardness testing machine with a Knoop indenter.

$$HK = k \frac{F}{A} = 0.102 \frac{F}{A} = 0.102 \frac{F}{cd^2} = 1.451 \frac{F}{d^2}$$

F: N  
d: mm  
c: Constant

### (3) Rockwell and Rockwell Superficial

To measure Rockwell or Rockwell Superficial hardness, first apply a preload force and then the test force to a specimen and return to the preload force using a diamond indenter (tip cone angle: 120°, tip radius: 0.2mm) or a sphere indenter (steel ball or carbide ball). This hardness value is obtained from the hardness formula expressed by the difference in indentation depth h (μm) between the preload and test forces. Rockwell uses a preload force of 98.07N, and Rockwell Superficial 29.42N. A specific symbol provided in combination with a type of indenter, test force, and hardness formula is known as a scale. Japanese Industrial Standards (JIS) define various scales of related hardness.



## Relationship between Vickers Hardness and the Minimum Allowable Thickness of a Specimen

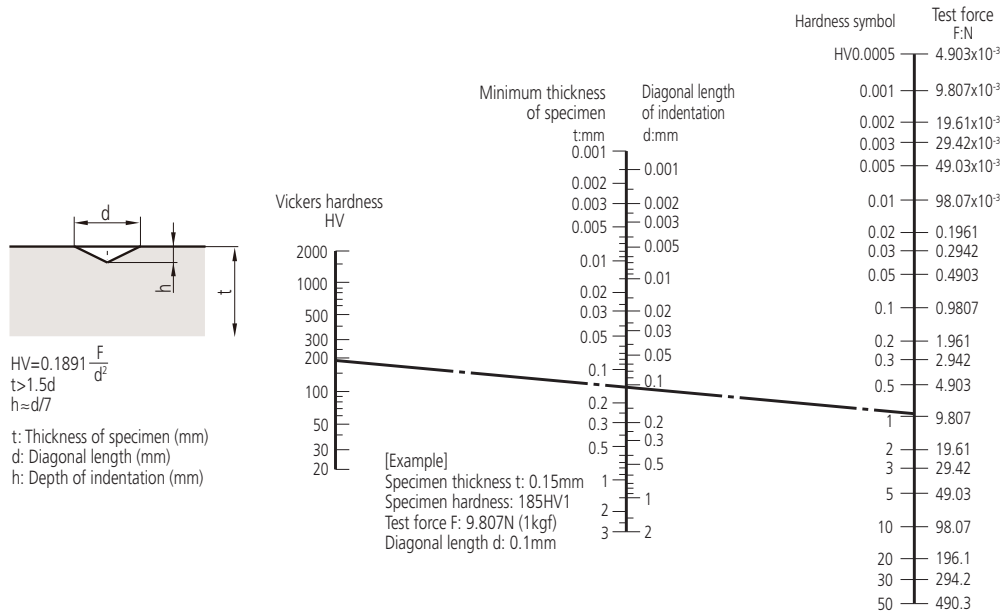

## Relationship between Rockwell/Rockwell Superficial Hardness and the Minimum Thickness of a Specimen

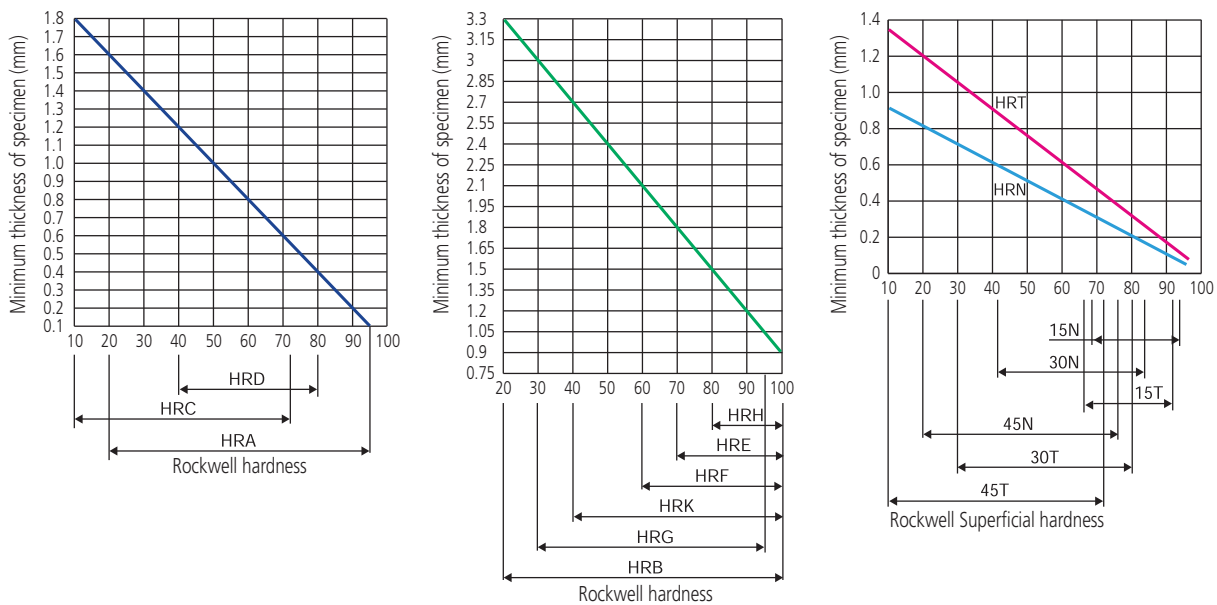

### Rockwell Hardness Scales

Scale	Indenter	Test force (N)	Application
A	Diamond**	588.4	<b>HRA:</b> Tungsten carbide and thin age-hardening steel or thinner surface layer than is HRC testable.
D		980.7	
C		1471	
F	Ball with a diameter of 1.5875mm	588.4	<b>HRC:</b> Tungsten carbide and age-hardening steel (tools, high-strength mild steel).
B		980.7	
G		1471	
H	Ball with a diameter of 3.175mm	588.4	<b>HRD:</b> Surface-hardened parts of average hardness.
E		980.7	
K		1471	
*L	Ball with a diameter of 6.35mm	588.4	<b>HRE:</b> Cast iron, aluminum alloys, magnesium alloys, bearing metals.
*M		980.7	
*P		1471	
*R	Ball with a diameter of 12.7mm	588.4	<b>HRF:</b> Cold rolled sheet metal, annealed bronze and copper.
*S		980.7	
*V		1471	

### Rockwell Superficial Hardness Scales

Scale	Indenter	Test force (N)	Application
15N	Diamond**	147.1	<b>HR15N, HR30N, HR45N:</b> Steels according to HRA, HRD and HRC for thin parts or thin hardened layers. <b>HR15T, HR30T, HR45T:</b> Soft steel and non-ferrous metals like HRF and HRB, in case of thin parts (e.g. deep-drawn sheet metal)
30N		294.2	
45N		441.3	
15T	Ball with a diameter of 1.5875mm	147.1	
30T		294.2	
45T		441.3	
*15W	Ball with a diameter of 3.175mm	147.1	
*30W		294.2	
*45W		441.3	
*15X	Ball with a diameter of 6.35mm	147.1	
*30X		294.2	
*45X		441.3	
*15Y	Ball with a diameter of 12.7mm	147.1	
*30Y		294.2	
*45Y		441.3	

\* Not part of ISO6508-1

\*\* Cone angle of the tip: 120°, Radius of curvature of the tip: 0.2mm

# Coordinate Measuring Machines

## ■ Performance Assessment Method of Coordinate Measuring Machines

Regarding the performance assessment method of coordinate measuring machines, JIS was revised in 2003. In the revised JIS, the standards for scanning measurement and rotary tables have been added to the conventional test items. Also, the concept of "uncertainty" has been incorporated into the latest JIS. At that point in 2003 the four items in Table 1 were standardized.

Table 1 JIS B 7440 (2003) Series

	Item	JIS Standard No.	Year of issue
1	Terms	JIS B 7440-1 (2003)	2003/4
2	Dimensional measurement	JIS B 7440-2 (2003)	2003/4
3	Rotary table-equipped CMM	JIS B 7440-3 (2003)	2003/4
4	Scanning measurement	JIS B 7440-4 (2003)	2003/4

## ■ Maximum Permissible Measuring Error $MPE_E$ [JIS B 7440-2 (2003)]

The test procedure under this standard is that a coordinate measuring machine (CMM) is made to perform a series of measurements on five different test lengths in each of seven directions, as shown in Figure 1, to produce a set of 35 measurements. This sequence is then repeated twice to produce 105 measurements in all. If these results, including allowances for the uncertainty of measurement, are equal to or less than the values specified by the manufacturer then the performance of the CMM has been proved to meet its specification.

The standard allows up to five measurements to exceed the specified value (two NG results among 3-time measurements in the same position are not allowed). If this is the case, additional 10-times measurements for the relevant position are performed. If all the 10 results, including the uncertainty allowance, are within the specified value, the CMM is assumed to pass the test. The uncertainties to be considered in determining the maximum permissible measuring error are those concerning calibration and alignment methods used with the particular material standards of length involved with the test. (The values obtained by adding an extended uncertainty combining the above two uncertainties to all test results must be less than the specified value.) The result of the test may be expressed in any of the following three forms (unit:  $\mu\text{m}$ ).

$$\begin{aligned} MPE_E &= A + L/K \leq B \\ MPE_E &= A + L/K \\ MPE_E &= B \end{aligned} \quad \left\{ \begin{array}{l} A: \text{Constant } (\mu\text{m}) \text{ specified by the manufacturer} \\ K: \text{Dimensionless constant specified by the manufacturer} \\ L: \text{Measured length (mm)} \\ B: \text{Upper limit value } (\mu\text{m}) \text{ specified by the manufacturer} \end{array} \right.$$

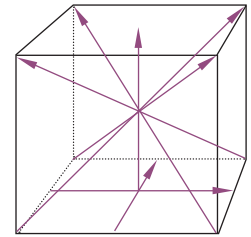

Figure 1 Typical test measurement directions within the CMM measuring volume

## ■ Maximum Permissible Probing Error $MPE_P$ [JIS B 7440-2 (2003)]

The test procedure under this standard is that a probe is used to measure defined target points on a standard sphere (25 points, as in Figure 2) and the result used to calculate the position of the sphere center by a least squares method. Then the distance R from the sphere center for each of the 25 measurement points is calculated, and the radius difference  $R_{\text{max}} - R_{\text{min}}$  is computed. An extended uncertainty that combines the uncertainty of the stylus tip shape and that of the standard test sphere is added to the radius difference. If this final calculated value is equal to or less than the specified value, the probe has passed the test.

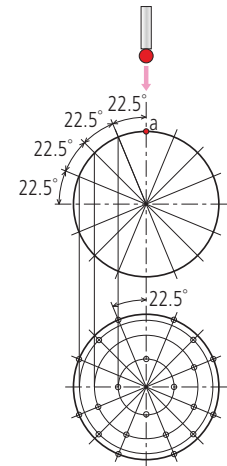

Figure 2 Target points on standard sphere for determining the Maximum Permissible Probing Error

## ■ Maximum Permissible Scanning Probing Error $MPE_{\text{THP}}$ [JIS B 7440-4 (2003)]

This is the accuracy standard for a CMM if equipped with a scanning probe. Scanning probing error was standardized in JIS B 7440-2 (2003) for the first time. The test procedure under this standard is to perform a scanning measurement of 4 planes on the standard sphere and then, for the least squares sphere center calculated using all the measurement points, calculate the range (dimension 'A' in Figure 3) in which all measurement points exist. Based on the least squares sphere center calculated above, calculate the distance between the calibrated standard sphere radius and the maximum measurement point or minimum measurement point, and take the larger distance (dimension 'B' in Figure 3). Add an extended uncertainty that combines the uncertainty of the stylus tip shape and the uncertainty of the standard test sphere shape to each A and B dimension. If both calculated values are less than the specified values, this scanning probe test is passed.

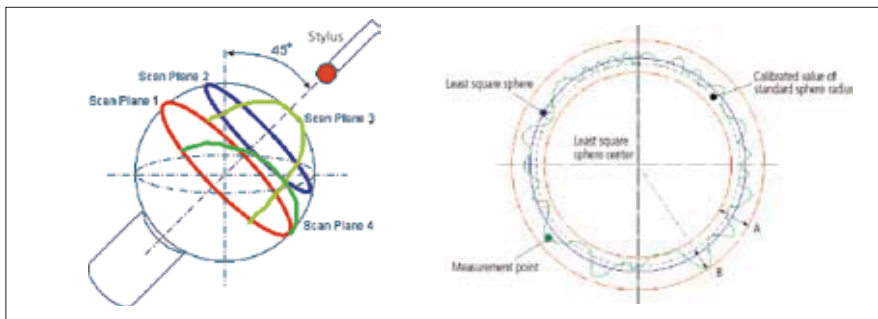

Figure 3 Target measurement planes for the maximum permissible scanning probing error and its evaluation concept

## ■ Maximum Permissible Rotation Axis Radial-Direction Error $MPE_{FR}$ Maximum Permissible Rotation Axis Connecting-Direction Error $MPE_{FT}$ and Maximum Permissible Rotation Axis Axial-Direction Error $MPE_{FA}$ [JIS B 7440-3 (2003)]

The test procedure under this standard is to place two standard spheres on the rotary table as shown in Figure 4. Rotate the rotary table to a total of 15 positions including 0°, 7 positions in the plus (+) direction, and 7 positions in the minus (-) direction and measure the center coordinates of the two spheres in each position. Then, add the uncertainty of the standard sphere shape to each variation (range) of radial direction elements, connecting direction elements, and rotational axis direction elements of the two standard sphere center coordinates. If these calculated values are less than the specified values, the evaluation test is passed.

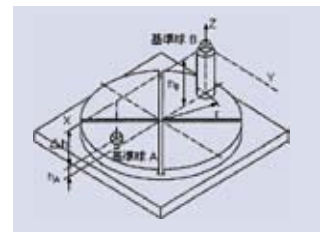

Figure 4 Evaluation of a CMM with a rotary table

**Quick Guide to Precision Measuring Instruments**

**No. E11003(2)**

Issued in Oct, 2012

Issued by Mitutoyo Corporation

20-1, Sakado-1Chome, Takatsu-ku, Kawasaki-shi,  
Kanagawa 213-8533, Japan



Export permission by the Japanese government may be required for exporting our products according to the Foreign Exchange and Foreign Trade Law. Please consult our sales office near you before you export our products or you offer technical information to a nonresident.

- Coordinate Measuring Machines
- Vision Measuring Systems
- Form Measurement
- Optical Measuring
- Sensor Systems
- Test Equipment and Seismometers
- Digital Scale and DRO Systems
- Small Tool Instruments and Data Management

### Mitutoyo Corporation

20-1, Sakado 1-Chome,  
Takatsu-ku, Kawasaki-shi,  
Kanagawa 213-8533, Japan  
T +81 (0) 44 813-8230  
F +81 (0) 44 813-8231  
<http://www.mitutoyo.co.jp>

Note: All information regarding our products, and in particular the illustrations, drawings, dimensional and performance data contained in this pamphlet, as well as other technical data are to be regarded as approximate average values. We therefore reserve the right to make changes to the corresponding designs, dimensions and weights. The stated standards, similar technical regulations, descriptions and illustrations of the products were valid at the time of printing. Only quotations submitted by ourselves may be regarded as definitive.

# Mitutoyo