

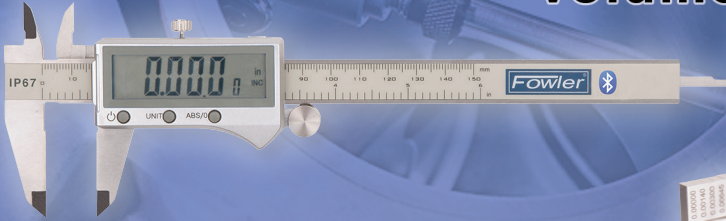

HIGH PRECISION

TOOL-A-THON[®]

Volume 19.1



Over 50 NEW items!



Valid January 1st - April 30th

www.fowlerprecision.com



Fowler - Trimos V3, V4 & V5 Electronic Height Gages

The Fowler-Trimos V3, V4 and V5 vertical measuring instruments have been developed for the most difficult workshop environments. Manufactured in their entirety in Switzerland, they guarantee a robust, precise and reliable product in the long run.

- "Black mask" display with user friendly functions
- Electronically adjustable measuring force 0.75/1.5 (N)
- Lithium-ion rechargeable batteries
- All adjustments possible without tools
- Cast iron base for optimal stability
- RS232 and USB interfaces requires 54-192-112-0 cable
- Dual probe holders (V4 and V5 Only)
- Carriage displacement: Manual
(V5 includes selectable manual or motorized carriage displacement)
- Measures heights, diameters, perpendicularity, centerlines, Min/Max/Delta
- Resolution: 0.00005"/0.001mm
- Repeatability (2s): 0.00008"/0.002mm (Ø 0.00016"/0.004mm)

All V Models Include:

- Charging unit
- Measuring insert with ruby ball Ø4mm
- Probe holder elbow Ø 8mm
- Setting gage
- User's manual and test certificate



54-192-340-0

V3	54-192-340-0	54-192-370-0
Measuring Range	16"/407mm	28"/711mm
Range with Probe inverted	20"/508mm	31.9"/812mm
Max. Permissible Errors	0.00028"/0.007mm	0.00032"/0.008mm
Frontal Squareness Deviation	0.0004"/0.010mm	0.0006"/0.015mm
Air Cushion		NO

V4	54-191-440-0	54-191-470-0
Measuring Range	16"/407mm	28"/711mm
Range with Probe inverted	28.3"/719mm	40.2"/1023mm
Max. Permissible Errors	0.0002"/0.005mm	0.00028"/0.007mm
Frontal Squareness Deviation	0.0004"/0.010mm	0.0006"/0.015mm
Air Cushion		YES

V5	54-199-540-0	54-199-570-0	54-199-590-0
Measuring Range	16"/407mm	28"/711mm	43.7"/1110mm
Range with Probe inverted	28.3"/719mm	40.2"/1023mm	56"/1422mm
Max. Permissible Errors (µm)		2.5 + L(mm)/300	
Frontal Squareness Deviation	0.0002"/0.005mm	0.00032"/0.008mm	0.00043"/0.011mm
Air Cushion		YES	

Order No.	Description
54-192-340-0	V3 Height Gage
54-192-370-0	V3 Height Gage
54-191-440-0	V4 Height Gage
54-191-470-0	V4 Height Gage
54-199-540-0	V5 Height Gage
54-199-570-0	V5 Height Gage
54-199-590-0	V5 Height Gage
Probe Sets	
54-199-105-0	4mm Probe Set, 21 piece
54-199-106-0	8mm Probe Set, 16 piece
54-199-107-0	Economy Probe Set, 7 piece
Accessories	
54-199-400-0	12"/300mm Holder - for 8mm probes
54-777-120-0	Vmox software - for connecting multiple units to one PC

IMPORTANT: Due to recent tariff increases, prices maybe subject to change.
 Prices & Specifications are subject to change without notice.

Fowler[®] TOOL-A-THON[®] Vol. 19.1

**EXTREMELY
Easy to Use!**



54-191-440-0



54-199-570-0



Range	List Price	Sale Price
16"/407mm	\$4543.03	\$4145.00
28"/711mm	5008.90	4505.00
16"/407mm	5984.16	5385.00
28"/711mm	6961.52	6265.00
16"/407mm	6595.41	5935.00
28"/711mm	7815.80	7030.00
43"/1100mm	12,090.35	10,880.00
	\$1747.81	\$1540.00
	1304.22	1200.00
	462.98	424.00
	\$978.33	\$850.00
	460.80	390.00

NOW
available with
ISO Cert.

Contact the Fowler
Sales Department 1-800-788-2353

IMPORTANT: Due to recent tariff increases, prices maybe subject to change.
Prices & Specifications are subject to change without notice.



Find us on social media!



Fowler - Sylvac Hi_Cal Electronic Height Gages

- Extra low measuring force, from 0.2N
- Measure internal and external diameters, centerlines, heights, widths, depths and MIN/MAX/TIR capability
- Excellent repeatability thanks to the motorized carriage
- High reliability
- Data output USB and RS232
- Battery life: 40 hours rechargeable during operation
- Touch sensitive probe speed for easy operation
- Base with small footprint
- Includes: protective cover, charging set, ruby ball probe Ø3mm, setting gage and calibration certificate



54-931-150-0

NOW
available with
ISO Cert.

Accessory Probe Sets



54-930-215-0



54-930-217-0

FREE 1mm Ball Probe with

Order No.	Range
54-931-150-0	6"/150mm
54-931-150-C	6"/150mm with ISO/A2LA Certification
54-931-300-0	12"/300mm
54-931-300-C	12"/300mm with ISO/A2LA Certification
54-931-450-0	17.5"/450mm
54-931-450-C	17.5"/450mm with ISO/A2LA Certification
Accessories	
54-930-215-0	Full Probe Accessory Set
54-930-217-0	Basic Probe Accessory Set

IMPORTANT: Due to recent tariff increases, prices maybe subject to change.
Prices & Specifications are subject to change without notice.



Watch the Demo!
You **Tube**
FowlerVid



Fowler
TOOL-A-THON
Vol. 19.1

FREE Basic Probe Set
 with 54-931-450-0 Hi_Cal Purchase
\$617.62 Value!

6"/150mm & 12"/300mm Hi_Cal Purchase

Accuracy	List Price	Sale Price
0.00013"/0.0034mm	\$4849.82	\$4300.00
0.00016"/0.0042mm	5573.46	4550.00
0.00020"/0.005mm	6093.03	5365.00
		5475.00
	\$1138.15	\$1025.00
	617.62	555.00

IMPORTANT: Due to recent tariff increases, prices maybe subject to change.
 Prices & Specifications are subject to change without notice.



Find us on social media!



Z-HEIGHT ABS PLUS+

Electronic Height Gages

- **NEW** True ABS measuring system
- Supplied with a NIST certified test block (1" x 2" x 3")
- Supplied with mini USB data cable
- Heavy duty single column design
- Carbide scriber
- Ground and lapped base for smooth movement
- Steel rack with large hand wheel for coarse and fine adjustment
- Positive locking level for scriber
- Can be used with wireless transmitter (54-115-100-0)



Order No.	Range	Accuracy	List Price	Sale Price
54-175-012-1	NEW 12"/300mm	± 0.0016"/0.04mm	\$601.78	\$530.00
54-175-018-1	NEW 18"/500mm	± 0.002"/0.05mm	708.90	625.00
54-175-024-1	NEW 24"/600mm	± 0.002"/0.05mm	813.96	710.00
Accessory				
54-115-100-0	Wireless transmitter		\$108.59	\$99.00

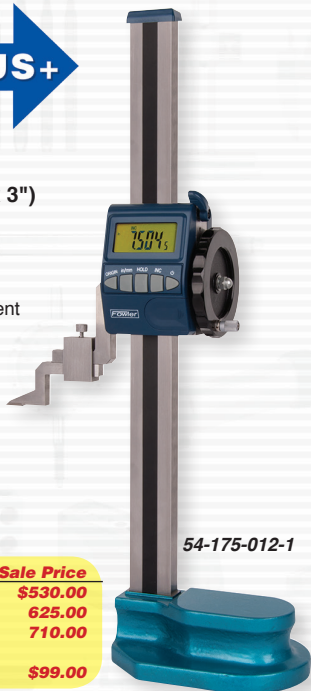

54-175-012-1

Z-HEIGHT

Electronic Height Gages

New Design!

- **NEW** base design with painted enamel finish has a more comfortable grip and is finely ground and lapped for smooth movement on surface plates
- **NEW** fine adjust feature allows precise adjustment to required settings
- **NEW** preset feature allows setting pre-determined or reference measurements
- **NEW** 2 indicator holding bars included (3/8" and 8mm)
- Direct inch/metric conversion
- Resolution 0.0005"/0.01mm
- Floating zero
- Large, high contrast LCD display
- Coarse adjustment hand wheel
- Carriage locking lever
- Carbide tipped scriber



Order No.	Range	Accuracy	List Price	Sale Price
54-175-012-0	NEW 12"/300mm	± 0.0016"/0.04mm	\$524.56	\$400.00
54-175-018-0	NEW 18"/500mm	± 0.002"/0.05mm	611.57	465.00
54-175-024-0	NEW 24"/600mm	± 0.002"/0.05mm	688.39	\$25.00



54-175-024-0

IMPORTANT: Due to recent tariff increases, prices maybe subject to change.
Prices & Specifications are subject to change without notice.

Twin Beam Electronic Height Gages with Offset Scriber

- Carriage design with offset scriber holder
- Base is ground and lapped for flatness
- Handwheel provides course and fine movement
- Updated electronic and mechanical design offers better accuracy and movement of carriage
- Carbide tipped scriber
- Functions include preset, in/mm conversion and ABS/INC for direct or comparative measuring

Optional contact sensor can be used to indicate when measuring contact is made between the gage and another conductive surface



54-174-212-3

Order No.	Range	Accuracy	List Price	Sale Price
54-174-212-3	12"/300mm	± 0.0016"/0.04mm	\$494.19	\$425.00
54-174-224-3	24"/600mm	± 0.002"/0.05mm	691.87	595.00
Accessory				
54-174-226-0	Contact sensor		\$21.85	\$18.00

Twin Beam Dial Height Gages

- Separate digit counters register both upward & downward travel
- Zero setting can be obtained throughout the gage's range
- Coarse readings in 0.100" graduations; fine readings taken on indicator are 0.001"
- Dual chrome plated beams
- Carbide-tipped scriber.
- Base is hardened, ground & lapped for maximum flatness

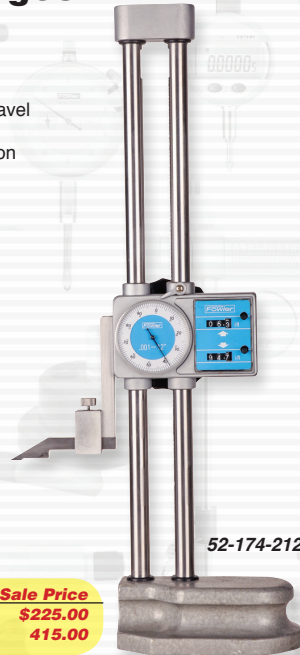

52-174-212-0

Order No.	Range	Accuracy	List Price	Sale Price
52-174-212-0	12"	± 0.0015"	\$296.51	\$225.00
52-174-224-0	24"	± 0.002"	494.19	415.00

IMPORTANT: Due to recent tariff increases, prices maybe subject to change. Prices & Specifications are subject to change without notice.



- Facebook icon
- Twitter icon
- LinkedIn icon
- YouTube icon

Find us on social media!

Machinist Grade Dial Calipers



52-008-706-0

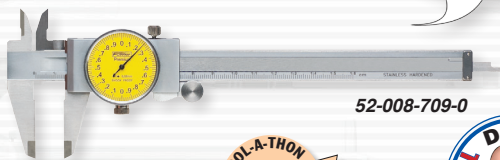

52-008-709-0

"Very precise with consistent readings. I would never change this analog for a digital one"
Erick T.

- 4-way measuring
- Solid stainless steel construction
- 0.100"/2mm range per revolution
- 0.001"/0.02mm reading dial face
- Tough shockproof gearing



Order No.	Range	Dial Face Color	Accuracy	List Price	Sale Price
52-008-706-0	0 - 6"	White	± 0.001"	\$81.60	\$60.00
52-008-708-0	0 - 8"	White	± 0.0015"	99.57	79.00
52-008-712-0	0 - 12"	White	± 0.002"	131.81	98.00
52-008-709-0	0 - 150mm (Metric Model)	Yellow	± 0.02mm	81.60	61.00

0 - 6" Dial Calipers

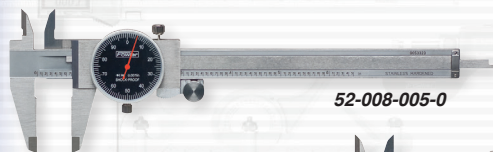

52-008-005-0

- 4-way measuring
- Covered rack
- Accuracy ± 0.001"
- 0.100" per revolution
- Dial graduation: 0.001"
- Hardened stainless steel rack

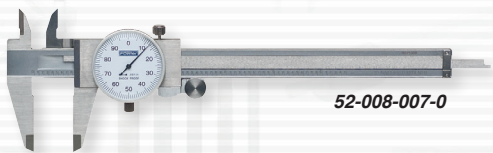

52-008-007-0

Order No.	Range	Dial Face Color	Accuracy	List Price	Sale Price
52-008-005-0	0 - 6"/150mm	Black	± 0.001"	\$93.33	\$60.00
52-008-007-0	0 - 6"/150mm	White	± 0.001"	86.70	60.00

Dial Cal Plus Dial Calipers

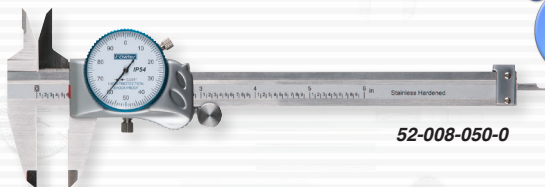

52-008-050-0



- 4-way measurement
- 0.100" per revolution
- Thumbroll for fine adjustment
- Carriage lock screw
- Heavy duty stainless steel frame - 4mm thick
- Adjustable bezel with lock

Order No.	Description	Accuracy	Graduation	List Price	Sale Price
52-008-050-0	0 - 6" - Whiteface	± 0.001"	0.001"	\$125.70	\$99.00
52-008-051-0	0 - 6" - Blackface	± 0.001"	0.001"	125.70	99.00
52-008-052-0	0 - 150mm - Whiteface	± 0.03mm	0.02mm	125.70	99.00

IMPORTANT: Due to recent tariff increases, prices maybe subject to change.
Prices & Specifications are subject to change without notice.

8" Heavy Duty Dial Caliper with Cross Jaws

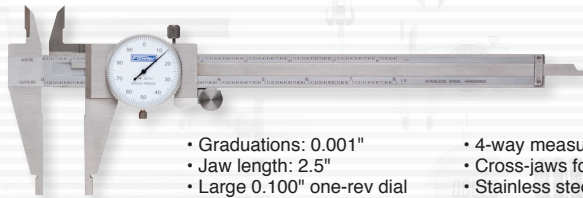

- Graduations: 0.001"
- Jaw length: 2.5"
- Large 0.100" one-rev dial
- Depth rod
- 4-way measurement
- Cross-jaws for direct internal measurement
- Stainless steel, satin chrome finish

Order No. 52-025-108-0

Sale \$112.00

List \$151.46

Premium Dial Caliper

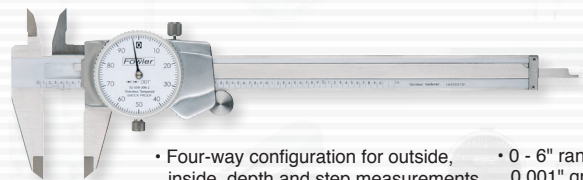

- Four-way configuration for outside, inside, depth and step measurements
- Solid stainless steel construction
- Silky smooth movement throughout
- 0 - 6" range, 0.100" per revolution, 0.001" graduations
- Thumbroll for rapid setting
- Knurled lock assures precise settings

Order No. 52-008-006-2

Sale \$110.00

List \$147.12

Vernier Calipers

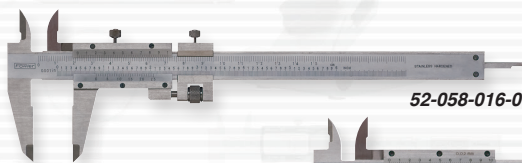

52-058-016-0

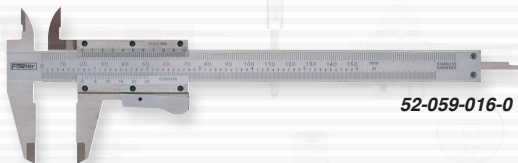

52-059-016-0

- Made of fully hardened stainless steel; microfine black graduations on a satin chrome finish for easy, precise reading
- All models offer a depth rod which can be read directly from verniers
- Measuring faces are ground and lapped for extreme accuracy
- 4-way jaws for outside, inside, depth and step measurements
- All sliding surfaces are raised to prevent defacement and wear of graduations

Order No.	Range	Graduation	Depth of Jaws	List Price	Sale Price
Vernier Caliper with Fine Adjustment					
52-058-016-0	0 - 6" / 0 - 150mm	0.001"/0.02mm	1.6"	\$51.69	\$35.00
52-058-008-0	0 - 8" / 0 - 200mm	0.001"/0.02mm	1.9"	75.64	50.00
52-058-012-0	0 - 12" / 0 - 300mm	0.001"/0.02mm	2.5"	117.28	80.00
Vernier Caliper with Thumb Lock					
52-059-016-0	0 - 6" / 0 - 150mm	0.001"/0.02mm	1.6"	46.68	30.00

IMPORTANT: Due to recent tariff increases, prices maybe subject to change.
Prices & Specifications are subject to change without notice.

Fowler®

TOOL-A-THON® Vol. 19.1



Find us on social media!

XTRA-VALUE Plus Electronic Calipers

INCH • METRIC • FRACTION™



54-103-006-0

NEW!



- Inch/Metric/Fraction reading: 0.0005"/0.01mm/ 1/128"
- Dust, water and oil resistant to IP54 standards making it **great for shop environments**
- Heavy Duty frame for extra rigidity and wear
- Super large, easy to read 14 x 52mm display
- Combined thumbrest and thumbroll for fine adjustment

Order No.	Range	Resolution	Accuracy	List Price	Sale Price
54-103-006-0	0 - 6"/150mm	0.0005"/0.01mm	± 0.001"/0.02mm	\$79.11	\$64.00
54-103-012-0	NEW 0 - 12"/300mm	0.0005"/0.01mm	± 0.0015"/0.04mm	135.00	120.00

XTRA-VALUE CAL Electronic Calipers

NEW! Buy a 12" **FREE**
Get a 6" **FREE**

Buy a 12" (54-101-300-1) at *list price* and get a 6" (54-101-150-2) **FREE**



"Great price, good quality, prompt processing"

Terri F.

- Accuracy: 0.001"/0.02mm (6" models)
- Stainless steel frame
- Large easy-to-read display
- Resolution: 0.0005"/0.01mm
- Absolute/Incremental Measurement
- 4-way measuring



Order No.	Range	Display Type	List Price	Sale Price
54-101-300-P	NEW Buy a 12" (54-101-300-1) and Get a 6" (54-101-150-2) FREE		\$152.05	\$101.33
54-101-150-2	6"/150mm	Regular Display - includes FREE NIST Cert.	50.72	40.00
54-101-600-1	6"/150mm	Super Large Display with hold feature	66.16	51.00
54-101-200-1	8"/200mm	Regular Display	79.36	65.00
54-101-800-1	8"/200mm	Super Large Display with hold feature	99.18	76.00
54-101-300-1	12"/300mm	Regular Display - includes FREE NIST Cert.	101.33	83.00
54-101-900-1	12"/300mm	Super Large Display with hold feature	132.44	111.00

IMPORTANT: Due to recent tariff increases, prices maybe subject to change.
Prices & Specifications are subject to change without notice.

IP67 **PLUS+** Electronic Calipers



IP67 & Bluetooth
All in one!

Available in February

- **NEW** HID Interface - no dongle needed
- **Extra** battery tray and 1" standard included
- Supplied with NIST certification
- Heavy duty frame with 4 way measuring
- Super large display
- Bluetooth in a value priced electronic caliper
- Protected to IP67



Order No.	Range	Accuracy	List Price	Sale Price
54-100-554-BT	NEW 0 - 4"/100mm	0.001"/0.02mm	\$180.00	\$160.00
54-100-556-BT	NEW 0 - 6"/150mm	0.001"/0.02mm	185.00	165.00
54-100-558-BT	NEW 0 - 8"/200mm	0.0015"/0.04mm	225.00	200.00
54-100-512-BT	NEW 0 - 12"/300mm	0.0015"/0.04mm	240.00	215.00

Economy Digital Calipers

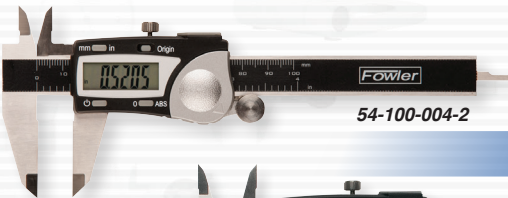

54-100-004-2

Absolute Reading!



54-100-000-2



- Absolute sensor technology
- Stainless steel frame
- 4-way measuring
- Resolution: 0.0005"/0.01mm

Order No.	Range	Accuracy	List Price	Sale Price
54-100-004-2	0 - 4"/100mm	0.001"/0.02mm	\$111.12	\$84.00
54-100-000-2	0 - 6"/150mm	0.001"/0.02mm	129.57	87.00
54-100-008-2	0 - 8"/200mm	0.0015"/0.04mm	152.15	115.00
Accessory				
54-115-100-0	Wireless transmitter		\$110.76	\$95.00

IMPORTANT: Due to recent tariff increases, prices maybe subject to change. Prices & Specifications are subject to change without notice.

Fowler TOOL-A-THON® Vol. 19.1



- Find us on social media!
-
-
-

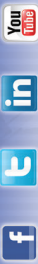

Bluetooth Ultra-Cal VI Electronic Calipers

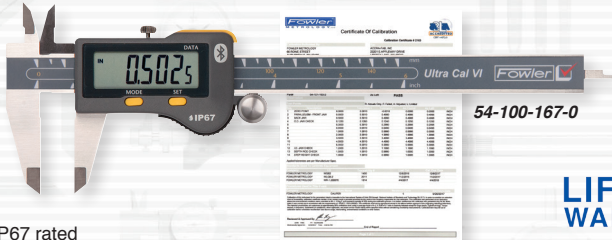

LIFETIME WARRANTY

- IP67 rated
- Available with or without Bluetooth
- Heavy duty frame
- Extra large display
- NOW available with ISO Cert.



Order No.	Description	Accuracy	Resolution	List Price	Sale Price
Without Data Output					
54-100-177-0	6"/150mm	0.0008"/20µm	0.0005"/0.01mm	\$119.65	\$105.00
54-100-178-0	8"/200mm	0.0012"/30µm	0.0005"/0.01mm	244.49	215.00
54-100-179-0	12"/300mm	0.0012"/30µm	0.0005"/0.01mm	327.73	295.00
Bluetooth					
54-100-167-0	6"/150mm	0.0008"/20µm	0.0005"/0.01mm	\$344.36	\$295.00
54-100-167-C	6"/150mm <i>with ISO/A2LA Certification</i>				324.00
54-100-168-0	8"/200mm	0.0012"/30µm	0.0005"/0.01mm	639.48	495.00
54-100-169-0	12"/300mm	0.0012"/30µm	0.0005"/0.01mm	852.07	650.00
Accessory					
54-115-246-BT	USB bluetooth receiver			\$50.24	\$45.00

Ultra-Cal V Electronic Calipers

Buy 5, Get 1 FREE!

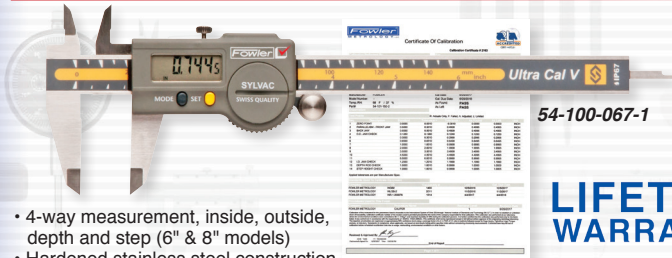

LIFETIME WARRANTY

- 4-way measurement, inside, outside, depth and step (6" & 8" models)
- Hardened stainless steel construction
- Direct RS232 output
- Features Absolute/Relative Measuring Modes
- Thumbroll (6" and 8" models only)
- NOW available with ISO Cert.



Order No.	Description	Accuracy	Resolution	List Price	Sale Price
54-100-667-0	Buy 5 standard 6"/150mm Electronic Calipers (54-100-067-1), Get 1 FREE			\$1033.05	\$825.00
54-100-067-1	6"/150mm	0.0008"/20µm	0.0005"/0.01mm	\$206.61	\$165.00
54-100-067-C	6"/150mm <i>with ISO/A2LA Certification</i>				194.00
54-100-068-1	8"/200mm	0.0012"/30µm	0.0005"/0.01mm	491.87	370.00
54-100-069-1	12"/300mm	0.0012"/30µm	0.0005"/0.01mm	590.24	490.00
Connectivity Cables					
54-115-526-0	Proximity cable with USB connection			\$141.57	\$125.00
54-115-527-0	Proximity cable with serial connection			141.57	125.00

IMPORTANT: Due to recent tariff increases, prices maybe subject to change. Prices & Specifications are subject to change without notice.



Ultra-Cal VI Proximity Electronic Calipers



54-100-444-1

LIFETIME WARRANTY 



IP67

- IP67 rated
- Ultra-Cal VI technology with proximity cable data output
- Heavy duty frame
- Extra large display

Order No.	Description	Accuracy	Resolution	List Price	Sale Price
54-100-444-1	6"/150mm	0.0008"/20µm	0.0005"/0.01mm	\$161.26	\$140.00
54-100-448-1	8"/200mm	0.0012"/30µm	0.0005"/0.01mm	291.31	250.00
54-100-412-1	12"/300mm	0.0012"/30µm	0.0005"/0.01mm	390.15	350.00
Connectivity Cables					
54-115-526-0	Proximity cable with USB connection			\$141.57	\$125.00
54-115-527-0	Proximity cable with serial connection			141.57	125.00

Micron 0.00005" Electronic Caliper

Absolute Reading!

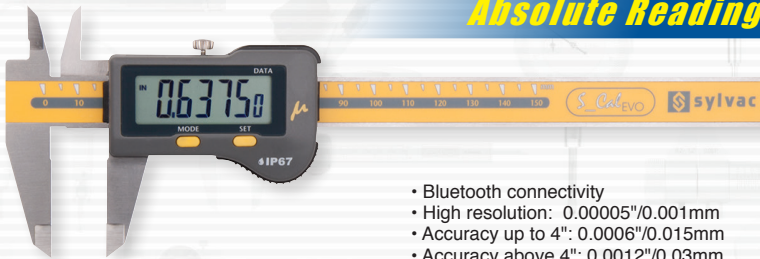

- Bluetooth connectivity
- High resolution: 0.00005"/0.001mm
- Accuracy up to 4": 0.0006"/0.015mm
- Accuracy above 4": 0.0012"/0.03mm
- Repeatability: 0.00016"/0.004mm
- Heavy duty frame (3.5mm)

LIFETIME WARRANTY 



IP67

Order No.	Description	List Price	Sale Price
54-100-100-0	6"/150mm Micron Electronic Caliper	\$400.07	\$325.00
Accessory			
54-115-246-BT	USB bluetooth receiver	\$50.24	\$45.00

IMPORTANT: Due to recent tariff increases, prices maybe subject to change.
Prices & Specifications are subject to change without notice.

Fowler® TOOL-A-THON® Vol. 19.1



Find us on social media!



XTRA-RANGE® Electronic Caliper

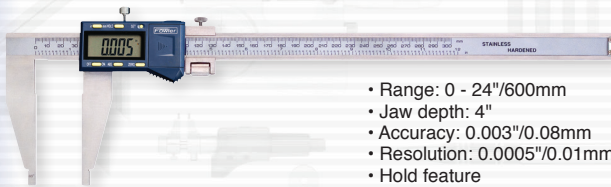

- Range: 0 - 24"/600mm
- Jaw depth: 4"
- Accuracy: 0.003"/0.08mm
- Resolution: 0.0005"/0.01mm
- Hold feature
- Absolute/Incremental measurement
- Preset mode includes offset size for ID measurements
- All sizes feature fine adjustment screw
- Includes shop hardened case

Order No. 54-100-024-1

Sale \$275.00

List \$333.33

Light Line Electronic Calipers

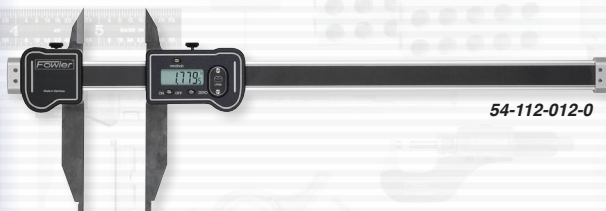

54-112-012-0



- Light weight beam made of oxide coated aluminum with double inner prismatic guide ways for optimal guidance and sliding characteristics
- Stainless steel jaws, hardened and finely ground with knife edge top jaws
- Jaws are adjustable and exchangeable
- Spare jaws can be modified and exchanged with standard jaws for special applications
- Both jaws are moveable to any position on the main beam
- Electronics feature on/off, floating zero and direct in/mm conversion
- 0.0005"/.01mm resolution and repeatability
- Includes a fitted case, instructions and test certificate

Order No.	Range	Accuracy	List Price	Sale Price
54-112-012-0	0 - 12"/300mm	0.0015"/0.04mm	\$313.06	\$260.00
54-112-030-0	0 - 31"/800mm	0.002"/0.06mm	721.62	605.00
Accessory				
52-075-150-0	6" replacement jaws		\$106.12	\$90.00

Extended Range Dial Caliper



- Graduations: 0.001"
- Jaw depth: 3.375"
- Stainless steel construction
- Satin chrome finish
- Depth rod
- 0.500" internal measuring nibs

Order No. 52-008-024-0

Sale \$235.00

List \$317.75

IMPORTANT: Due to recent tariff increases, prices maybe subject to change.
Prices & Specifications are subject to change without notice.

Fowler-Sylvac Ultralight IV Electronic Calipers

The Fowler-Sylvac Ultralight IV, new design, new features, built-in Bluetooth transmitter. Discover our amazing Ultralight long range calipers.

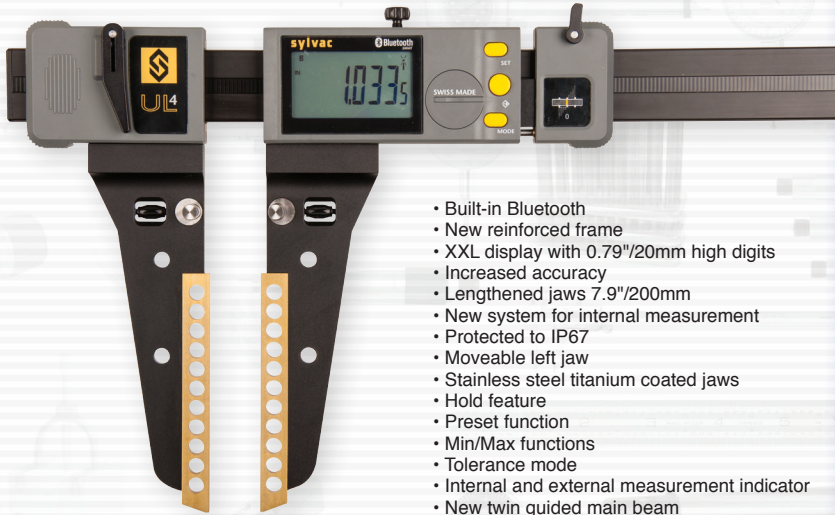

- Built-in Bluetooth
- New reinforced frame
- XXL display with 0.79"/20mm high digits
- Increased accuracy
- Lengthened jaws 7.9"/200mm
- New system for internal measurement
- Protected to IP67
- Moveable left jaw
- Stainless steel titanium coated jaws
- Hold feature
- Preset function
- Min/Max functions
- Tolerance mode
- Internal and external measurement indicator
- New twin guided main beam



Swiss Quality!



Alternative jaws available, contact the Fowler Technical Department for more information 1-800-788-2353

Specifications	54-110-512-0	54-110-524-0	54-110-540-0	54-110-560-0	54-110-580-0	54-110-600-0
Measuring Range	0-15"/0-400mm	0-24"/0-600mm	0-40"/0-1000mm	0-60"/0-1500mm	0-80"/0-2000mm	0-100"/0-2500mm
Maximum Error	30µm/0.0012"	40µm/0.0016"	50µm/0.002"	90µm/0.0035"	120µm/0.0048"	200µm/0.0078"
Repeatability	20µm/0.0008"				30µm/0.0012"	
Measuring Force	5 - 10 N					
Connection	Bluetooth Smart/Proxi. - RS-232 or - USB					
Protection Rating	IP67 (Electronic Module)					
Preset Max.	±9999.99 mm / ±399.9995 IN					
Weight	1.5 kg	1.6 kg	1.9 kg	2.3 kg	2.6 kg	2.9 kg

Order No.	Range	List Price	Sale Price
54-110-512-0	0 - 15" / 0 - 400mm	\$2102.65	\$1830.00
54-110-524-0	0 - 24" / 0 - 600mm	2454.30	2175.00
54-110-540-0	0 - 40" / 0 - 1000mm	2824.69	2540.00
54-110-560-0	0 - 60" / 0 - 1500mm	4246.91	3830.00
54-110-580-0	0 - 80" / 0 - 2000mm - special order	5851.21	5200.00
54-110-600-0	0 - 100" / 0 - 2500mm - special order	7070.56	6400.00
Connectivity Cables/Accessory			
54-115-526-0	Proximity USB Cable	\$141.57	\$125.00
54-115-527-0	Proximity Serial Cable	141.57	125.00
54-115-246-BT	USB Bluetooth Receiver	50.24	45.00

IMPORTANT: Due to recent tariff increases, prices maybe subject to change. Prices & Specifications are subject to change without notice.

Fowler®

TOOL-A-THON® Vol. 19.1



Find us on social media!

f

e

in

YouTube

Outside Inch Micrometers



52-240-101-1

- Microfine graduations on satin chrome finish and carbide tipped measuring faces
- Diameter of measuring faces: 0.256"
- Graduation: 0.0001"
- Flatness: 0.00003"
- Positive lever locking clamp
- Spindle thread hardened, ground and lapped for ultimate accuracy
- Anvil & spindle hardened and precision ground with microlap finish on tips
- Includes a wrench and case



52-215-003-1

Order No.	Range	Accuracy	Thimble	List Price	Sale Price
52-240-101-1	0 - 1"	± 0.00015"	Ratchet	\$42.43	\$34.00
52-240-102-1	1 - 2"	± 0.00015"	Ratchet	49.33	39.00
Set					
52-215-003-1	0 - 3" with standards			\$183.63	\$131.00

Outside Inch Micrometer Set

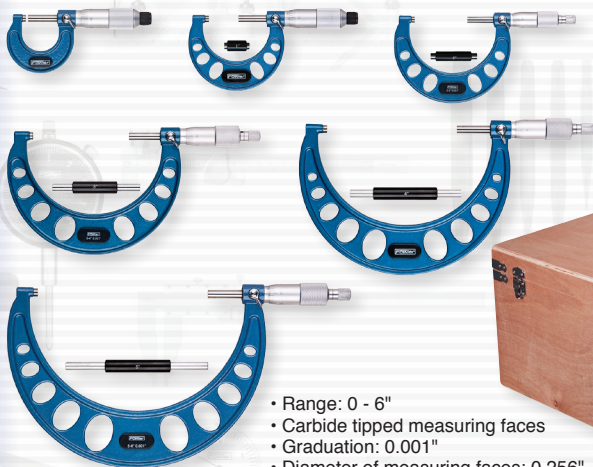

- Range: 0 - 6"
- Carbide tipped measuring faces
- Graduation: 0.001"
- Diameter of measuring faces: 0.256"
- Positive locking lever
- Anvil & spindle hardened and precision ground with microlap finish on tips
- Includes standard with sizes 2" and over

Order No. 52-253-600-1

Sale \$255.00

List \$327.69

IMPORTANT: Due to recent tariff increases, prices maybe subject to change.
Prices & Specifications are subject to change without notice.

Find us on social media!

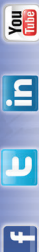

TOOL-A-THON® Vol. 19.1



Outside Inch Micrometers

with Decimal Equivalents on Frame



52-235-001-1



- Black decimal equivalents on satin chrome finished forged steel frame
- Graduations: 0.0001"
- Ratchet thimble and locking nut
- Includes standard for 1-2" sizes

Order No.	Range	Accuracy	Thimble	List Price	Sale Price
52-235-001-1	0 - 1"	± 0.0001"	Ratchet	\$67.56	\$49.00
52-235-002-2	1 - 2"	± 0.0001"	Ratchet	78.20	57.00
52-235-003-2	2 - 3"	± 0.0001"	Ratchet	97.76	71.00
Set					
52-235-100-0	0 - 3"			\$245.14	\$216.00

Swiss-Style Micrometers



52-229-201-0



"Awesome set of mics!"
Erik

- 0.0001" reading
- Carbide measuring faces
- Insulated frame
- Ratchet thimble and locking lever
- Microfine graduations
- Sizes over 1" include standard
- Includes case



52-229-213-0

Order No.	Range	Accuracy	List Price	Sale Price
52-229-201-0	0 - 1"	± 0.00016"	\$54.95	\$40.00
52-229-202-0	1 - 2"	± 0.00016"	64.35	47.00
52-229-203-0	2 - 3"	± 0.0002"	79.34	58.00
52-229-204-0	3 - 4"	± 0.0002"	91.08	66.00
52-229-205-0	4 - 5"	± 0.00024"	112.48	82.00
52-229-206-0	5 - 6"	± 0.00024"	132.11	97.00
Sets				
52-229-213-0	0 - 3"		\$198.09	\$145.00
52-229-214-0	0 - 4"		280.45	206.00
52-229-220-0	0 - 100mm		280.45	206.00

IMPORTANT: Due to recent tariff increases, prices maybe subject to change.
Prices & Specifications are subject to change without notice.

Fowler®

TOOL-A-THON® Vol. 19.1



Find us on social media!

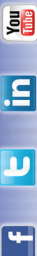

Digit Counter Micrometers



52-224-001-0



52-224-103-0

- Digital counter reads to 0.001"
- Resolution: 0.0001" (using vernier)
- Microfine graduations on satin chrome
- Carbide tipped measuring faces
- Positive locking nut on spindle
- Sizes over 1" include standard
- Includes case

Order No.	Range	List Price	Sale Price
52-224-001-0	0 - 1"	\$116.01	\$80.00
52-224-002-0	1 - 2"	121.87	84.00
52-224-003-0	2 - 3"	138.81	96.00
52-224-004-0	3 - 4"	152.69	105.00
52-224-005-0	4 - 5"	161.61	111.00
52-224-006-0	5 - 6"	168.98	117.00
Sets			
52-224-103-0	0 - 3" set	\$366.22	\$254.00
52-224-104-0	0 - 4" set	519.31	359.00
52-224-220-0	0 - 75mm set	385.60	267.00

Large Capacity Inch Micrometers

Fowler's Large Capacity Inch Micrometers are used for larger applications and is available in sizes up to a 20". Each micrometer offers superior design and workmanship to ensure high precision and long life — and at economical prices.



52-240-013-0

- Hammertone blue baked finish
- Microfine graduations on satin chrome finish and carbide tipped measuring faces.
- Diameter of measuring faces: 0.295"
- Ratchet stop thimble for exact and repetitive readings
- Flatness: 0.00003"
- Quick, easy zero adjustment on sleeve
- Positive lever locking clamp ensures reliable measurement setting at all times
- Anvil & spindle hardened and precision ground with microlap finish on tips
- Includes standard
- Includes a wrench and case

Order No.	Range	Graduation	Accuracy	List Price	Sale Price
52-240-013-0	12 - 13" w/standards & case	0.001"	0.00044"/0.011mm	\$357.75	\$265.00
52-240-014-0	13 - 14" w/standards & case	0.001"	0.00044"/0.011mm	399.71	299.00
52-240-015-0	14 - 15" w/standards & case	0.001"	0.00044"/0.011mm	411.36	308.00
52-240-016-0	15 - 16" w/standards & case	0.001"	0.00044"/0.011mm	449.76	335.00
52-240-017-0	16 - 17" w/standards & case	0.001"	0.0005"/0.013mm	462.11	345.00
52-240-018-0	17 - 18" w/standards & case	0.001"	0.0005"/0.013mm	501.81	375.00
52-240-019-0	18 - 19" w/standards & case	0.001"	0.0005"/0.013mm	530.69	395.00
52-240-020-0	19 - 20" w/standards & case	0.001"	0.0005"/0.013mm	634.80	475.00

IMPORTANT: Due to recent tariff increases, prices maybe subject to change. Prices & Specifications are subject to change without notice.



Deep Throat Electronic Micrometers



54-517-002-0



54-517-001-0

- Range: 0 - 1"/0 - 25mm
- Resolution: 0.00005"/0.001mm
- ABS/INC modes
- Ratchet thimble



Order No.	Anvil	Accuracy	Throat Depth	List Price	Sale Price
54-517-001-0	Flat	± 0.00012"/0.003mm	6"	\$220.00	\$200.00
54-517-002-0	Ball	± 0.00016"/0.004mm	11.875"	245.00	220.00

Deep Throat Vernier Micrometers

Fowler's "U"-frame Deep Throat Micrometers are available with depths of 6" and 12". Use Deep Throat Micrometers for taking accurate measurements of steel and plastic sheets and plates whenever a depth measurement of 2" to 12" is needed.

- Hammertone blue baked enamel frame
- Graduations are microfine on satin chrome finish for easy reading
- All models feature a ratchet stop thimble for exact and repetitive readings
- The spindle thread is hardened, ground and lapped. The anvil and spindle are hardened and precision ground with microlap finish on carbide tipped measuring faces.
- Diameter of measuring faces = 0.256"
- Positive lever locking clamp ensures reliable measurement at all times
- Wrench furnished with each micrometer for fast, easy zero adjustment on the sleeve
- Flatness: 0.00003"
- Parallelism: 0.00005"
- **52-517-612-1 supplied with a ball anvil**
- Includes case



52-517-611-1

Order No.	Range	Graduation	Accuracy	Anvil	Throat Depth	List Price	Sale Price
52-517-611-1	0 - 1"	0.0001"	0.00016"	Flat	6"	\$148.36	\$120.00
52-517-612-1	0 - 1"	0.0001"	0.0002"	Ball	11.875"	185.06	148.00

IMPORTANT: Due to recent tariff increases, prices maybe subject to change. Prices & Specifications are subject to change without notice.



Electronic IP54 Blade Micrometers



54-860-241-0



- Water resistant to IP54 specifications
- True inch/metric conversion
- Accuracy: 0.00016"
- Resolution: 0.00005"/0.001mm
- Friction thimble
- Sizes over 1" include standard

Order No.	Range	List Price	Sale Price
54-860-241-0	0 - 1" Blade Anvil	\$269.86	\$200.00
54-860-242-0	1 - 2" Blade Anvil with standard	293.15	218.00
54-860-243-0	2 - 3" Blade Anvil with standard	306.19	228.00
54-860-244-0	3 - 4" Blade Anvil with standard	320.47	240.00

Vernier Inch Blade Micrometers



52-246-001-1

- Use blade micrometers to measure the outside diameter of workpieces which have narrow grooves, "T" slots and other dimensions
- Anvil & spindle hardened & precision ground with microlap finish on ends
- Non-rotating spindle
- Ratchet thimble
- Blade thickness = 0.030"; blade width = 0.256"; blade penetration = 0.315"
- Sizes over 1" include a standard

Order No.	Range	Graduation	Accuracy	List Price	Sale Price
52-246-001-1	0 - 1"	0.0001"	0.00016"	\$218.65	\$160.00
52-246-002-1	1 - 2"	0.0001"	0.00016"	238.02	175.00
52-246-003-1	2 - 3"	0.0001"	0.0002"	248.37	185.00
52-246-004-1	3 - 4"	0.0001"	0.0002"	253.29	190.00

IMPORTANT: Due to recent tariff increases, prices maybe subject to change. Prices & Specifications are subject to change without notice.

Ball-Anvil Micrometers



52-244-101-1

- Microfine graduations on satin chrome
- Anvil and spindle hardened and ground; spindle thread hardened, ground and lapped
- Ratchet stop thimble for exact readings
- Accuracy: 0.00016"
- Graduation: 0.0001"

Order No.	Range	List Price	Sale Price
52-244-001-1	0 - 1" Ball Anvil	\$84.16	\$63.00
52-244-101-1	0 - 1" Ball Anvil & Ball Spindle	99.13	74.00

Digit Counter Ball-Anvil Micrometers



52-244-201-1

- Microfine graduations on satin chrome.
- Digital counter reads to 0.001"; sleeve reads to 0.0001"
- No. 52-244-201-1 spindle hardened and precision ground with a carbide tipped measuring face
- No. 52-244-301-1 anvil is hardened and precision ground
- Spindle thread hardened, ground & lapped
- Ratchet stop thimble on all models
- Accuracy: 0.00016"
- Graduation: 0.0001"

Order No.	Range	List Price	Sale Price
52-244-201-1	0 - 1" Ball Anvil	\$121.87	\$90.00
52-244-202-1	1 - 2" Ball Anvil	146.96	108.00
52-244-301-1	0 - 1" Ball Anvil & Spindle	129.25	96.00

Electronic IP54 Ball-Anvil Micrometers



54-860-113-0



54-860-211-0

- Measures dimensions from inside of circular holes to outside edges and obtain accurate dimensions
- Carbide measuring faces
- True inch/metric conversion
- Resolution: 0.00005"/0.001mm
- Accuracy: 0.00016"/0.004mm
- Large easy-to-read LCD display



Order No.	Range	List Price	Sale Price
54-860-113-0	0 - 1"/0 - 25mm Ball Anvil & Flat Spindle	\$204.39	\$150.00
54-860-114-0	1 - 2"/25 - 50mm Ball Anvil & Flat Spindle	218.00	160.00
54-860-211-0	0 - 1"/0 - 25mm Ball Anvil & Ball Spindle	204.39	150.00
54-860-212-0	1 - 2"/25 - 50mm Ball Anvil & Ball Spindle	218.00	160.00

IMPORTANT: Due to recent tariff increases, prices maybe subject to change. Prices & Specifications are subject to change without notice.



Rapid-Mic Quick-Displacement Electronic Micrometers



54-815-030-0

**WORLD'S FINEST
Micrometer!**

NOW
available with
ISO Cert.

"I have been in the machining business for over 30 years this is by far the best mic I have ever had. One little thing or should I rephrase that, one huge thing, this mic comes with a lifetime warranty... no other company can provide that!"

John T.

NEW Bluetooth Ranges NOW Available!

- Position recall
- Delrin quick displacement thimble
- Adjustable measuring force, 5N/10N (54-815-030-0 only)
- Menu customizable with free software
- Non-rotating spindle, 10mm/spindle rotation
- USB output or bluetooth available

LIFETIME WARRANTY



Watch the Demo!
You Tube
FowlerVid



**0-4" Range
with ONLY
3 Mics!**

54-815-111-0

Order No.	Description	Max Error	List Price	Sale Price
54-815-030-0	0 - 1.18"/0 - 30mm	0.00012"/0.003mm	\$535.59	\$435.00
54-815-030-C	1.18"/30mm with ISO/A2LA Certification			460.00
54-815-060-0	1.18" - 2.6"/30 - 66mm	0.00016"/0.004mm	792.51	710.00
54-815-100-0	2.6" - 4.0"/66 - 102mm	0.00020"/0.005mm	1108.33	960.00
Set				
54-815-111-0	0 - 4"/0 - 102mm		\$2416.85	\$1995.00
Bluetooth Model				
54-815-130-0	0 - 1.18"/0 - 30mm	0.00012"/0.003mm	\$792.51	\$669.00
54-815-160-0	1.18" - 2.6"/30 - 66mm	0.00016"/0.004mm	1048.72	955.00
54-815-110-0	2.6" - 4.0"/66 - 102mm	0.00020"/0.005mm	1365.00	1199.00
Bluetooth Set				
54-815-112-0	0 - 4"/0 - 102mm		\$2997.39	\$2499.00
Connectivity Cables/Accessory				
54-115-526-0	Proximity cable with USB connection		\$141.57	\$125.00
54-115-527-0	Proximity cable with serial connection		141.57	125.00
54-115-246-BT	USB Bluetooth receiver		50.24	45.00

IMPORTANT: Due to recent tariff increases, prices maybe subject to change.
Prices & Specifications are subject to change without notice.

XTRA-MIC[®] PLUS+ Electronic Micrometers



NEW!

Great for Shop Environments!

- Corrosive resistant ratchet thimble (anodized aluminum)
- Super large LCD display, 14mm height
- Resolution: 0.00005"/0.001mm
- IP54 protected against fluid and dust
- Spindle lock
- Carbide tipped anvil and spindle
- SPC output
- Includes fitted case



Order No.	Range	Accuracy	List Price	Sale Price
54-880-001-0	NEW 0 - 1" / 0 - 25mm	0.00016"/0.004mm	\$138.00	\$124.00
54-880-002-0	NEW 1 - 2" / 25 - 50mm	0.00016"/0.004mm	159.00	142.00
54-880-003-0	NEW 2 - 3" / 50 - 75mm	0.0002"/0.005mm	170.00	152.00
54-880-004-0	NEW 3 - 4" / 75 - 100mm	0.0002"/0.005mm	195.00	174.00
Set				
54-880-103-0	NEW 0 - 3" / 0 - 75mm		\$439.00	\$390.00
Accessory				
54-520-399-0	SPC cable		\$170.22	\$120.00

INDI-X[®] Indicating Micrometers



- Anvil and spindle hardened and precision ground
- Fully insulated frame, satin chrome finish
- Carbide tipped anvil & spindle
- Retracting button conveniently located in relation to operator's hand
- 0 - 1" Range, head graduated in 0.001"
- Flatness: 0.000012"
- Dial graduated in 0.00005"
- Diameter of spindle: 0.256"
- Includes case

Order No.	Range	Accuracy	List Price	Sale Price
52-245-501-0	0 - 1"	0.00016"	\$356.45	\$265.00
52-245-502-0	1 - 2"	0.00016"	413.40	310.00

IMPORTANT: Due to recent tariff increases, prices maybe subject to change.
Prices & Specifications are subject to change without notice.

Fowler[®] TOOL-A-THON[®] Vol. 19.1



- Facebook
- Twitter
- LinkedIn
- YouTube



XTRA-VALUE II Electronic Micrometers



54-870-001-0

- Resolution: 0.00005"/0.001mm
- Accuracy: ± 0.00016"/0.004mm (up to 2")
- Carbide measuring faces
- Absolute and incremental modes
- Ratchet thimble



Order No.	Range	List Price	Sale Price
54-870-001-0	0 - 1"/0 - 25mm	\$99.18	\$72.00
54-870-002-0	1 - 2"/25 - 50mm	107.10	79.00
54-870-003-0	2 - 3"/50 - 75mm	121.38	88.00
54-870-004-0	3 - 4"/75 - 100mm	135.66	99.00
Set			
54-870-103-0	0 - 3"/0 - 75mm Set	\$292.27	\$210.00

Electronic Coolant Resistant Micrometers



54-860-001-1

- Protected to IP54 specifications
- Automatic switch off
- Accuracy: ± 0.00016"/0.004mm (up to 2")
- Resolution: 0.00005"/0.001mm
- Carbide measuring faces
- Absolute & incremental modes



Order No.	Range	List Price	Sale Price
54-860-001-1	0 - 1"/0 - 25mm	\$125.67	\$95.00
54-860-002-1	1 - 2"/25 - 50mm	145.50	109.00
54-860-003-1	2 - 3"/50 - 75mm	158.69	119.00
54-860-004-1	3 - 4"/75 - 100mm	184.17	137.00
54-860-005-1	4 - 5"/100 - 125mm	206.28	154.00
54-860-006-1	5 - 6"/125 - 150mm	231.51	170.00
Set			
54-860-103-1	0 - 3"/0 - 75mm Set	\$413.37	\$305.00

Fowler-Bowers XT-Series Holemikes

52-255-316-0



SPECIAL DEAL!

The Fowler-Bowers range of mechanical two and three point bore micrometers are now available as XT extended travel holemikes, allowing a wide measurement range without the need to interchange anvils.



- 3-pt contact with tungsten carbide measuring anvils above 0.5"
- Blind bore measuring heads featured above 0.5"
- Ratchet stop for consistent measuring
- Extensions available for deep measuring
- Includes UKAS certificates for all Holemikes and setting rings

Order No.	Range	Grads.	Accuracy	Meas. Depth	Ring Included	List Price	Sale Price
52-255-310-0	0.250" - 0.312"	0.00025"	0.00015"	2.28"	0.312"	\$737.86	\$565.00
52-255-311-0	0.312" - 0.375"	0.00025"	0.00015"	2.28"	0.312"	683.21	525.00
52-255-312-0	0.375" - 0.500"	0.00025"	0.00015"	2.28"	0.5"	683.21	525.00
52-255-313-0	0.500" - 0.625"	0.00025"	0.00015"	2.44"	0.5"	683.21	525.00
52-255-314-0	0.625" - 0.750"	0.00025"	0.00015"	2.44"	0.75"	700.61	535.00
52-255-315-0	0.750" - 1"	0.00025"	0.00015"	2.60"	0.75"	769.48	590.00
52-255-316-0	1" - 1.375"	0.00025"	0.00015"	2.60"	1.375"	1096.34	840.00
52-255-317-0	1.375" - 2"	0.00025"	0.00015"	3.15"	1.375"	1122.55	860.00
52-255-318-0	2" - 2.625"	0.00025"	0.0002"	3.15"	2.625"	1339.04	1030.00
52-255-319-0	2.625" - 3.250"	0.00025"	0.0002"	3.15"	2.625"	1351.02	1040.00
52-255-320-0	3.250" - 4"	0.00025"	0.0002"	3.94"	3.25"	1685.52	1295.00

Fowler-Bowers XT-Series Holemike Sets

Order No.	Range	Includes	List Price	Sale Price
52-255-565-0	0.250" - 0.375"	2 heads, 2 handles, 1 ring	\$1638.31	\$1260.00
52-255-665-0	0.375" - 0.750"	3 heads, 3 handles, 2 rings	1865.31	1430.00
52-255-775-0	0.750" - 2"	3 heads, 3 handles, 2 rings	2931.59	2250.00
52-255-885-0	2" - 4"	3 heads, 3 handles, 2 rings	3974.33	3210.00

Electronic Indicating Micrometers

A superior tool in quality and design, the Fowler-Bowers Electronic Indicating Micrometer operates quickly and easily.

- Retractable anvil travel: 0.275"/7mm
- Non-rotating spindle
- Switchable resolution 0.0005"/0.00005" (0.01/0.001mm)
- Repeatability: 0.00005" (1µm)
- Measuring force 4.5 - 6N
- Carbide tipped measuring faces
- Adjustable table for part
- Two reference memories
- Preset Recall function
- Hold/freeze display function
- Direct inch/metric conversion
- Tolerance indication
- Min/Max/TIR function
- Bidirectional RS232 output
- Includes case



54-245-777-0
Stand not included



Order No.	Description	List Price	Sale Price
54-245-777-0	0 - 1.25"/0 - 30mm	\$1232.35	\$1050.00
54-245-780-0	1.25" - 2.50"/30 - 60mm	1492.06	1200.00
Connectivity Cable			
54-115-336-0	Duplex opto cable	\$175.95	\$140.00

IMPORTANT: Due to recent tariff increases, prices maybe subject to change. Prices & Specifications are subject to change without notice.

Fowler

TOOL-A-THON® Vol. 19.1



Find us on social media!

f

e

in

YouTube



Fowler-Bowers **BLUETOOTH** XTH3 Holematic Pistol Grip Sets



TABLET!

with Complete Set Purchase!



"Fowler-Bowers makes an awesome product!"
T.T.



54-567-050-BT

- Self centering 3 point heads above 0.250"
- USB connectivity and Bluetooth
- Resolution: 0.00005"/0.001mm
- IP67 rated
- To reduce hand fatigue, the travel of the Holematic trigger is adjustable for minimum over travel
- Tungsten carbide measuring faces on all 3-point heads from 0.5" (12.5mm) and up
- Sizes over 0.500" (12.5mm) feature blind bore capability
- Includes UKAS certificates for all pistol grip, heads and rings

Contact the Fowler Technical Department for special measuring applications

Order No.	Range	Includes	List Price	Sale Price
54-567-009-BT	0.080" - 0.250"/2 - 6mm (2-point heads)	5 heads, 1 handle, 3 rings	\$6260.07	\$5090.00
54-567-010-BT	0.250" - 0.375"/6 - 10mm	2 heads, 1 handle, 1 ring	2454.58	1995.00
54-567-020-BT	0.375" - 0.750"/10 - 20mm	3 heads, 1 handle, 2 rings	2871.63	2335.00
54-567-050-BT	0.750" - 2" /20 - 50mm	3 heads, 1 handle, 2 rings	3707.86	3015.00
54-567-100-BT	2 - 4"/50 - 100mm	3 heads, 1 handle, 2 rings	4127.04	3355.00
54-567-105-BT	4 - 6"/100 - 150mm	2 heads, 1 handle, 1 ring	3707.86	3015.00
54-567-110-BT	6 - 8" /150 - 200mm	2 heads, 1 handle, 1 ring	4894.29	3980.00
54-567-200-BT	4 - 8" /100 - 200mm	4 heads, 1 handle, 2 rings	7746.82	6300.00
54-567-210-BT	0.750" - 4" /20 - 100mm	6 heads, 1 handle, 4 rings	6034.02	4900.00
54-567-620-BT	0.250" - 0.750" /6 - 20mm	5 heads, 1 handle, 3 rings	3422.40	2780.00
Connectivity Cables/Accessory				
54-115-526-0	Proximity cable with USB connection		\$141.57	\$125.00
54-115-527-0	Proximity cable with serial connection		141.57	125.00
54-115-246-BT	USB bluetooth receiver		50.24	45.00

IMPORTANT: Due to recent tariff increases, prices maybe subject to change.
Prices & Specifications are subject to change without notice.



Fowler-Bowers **BLUETOOTH** XTD3 Electronic Holemike Sets



FREE

with Complete Set Purchase!

54-367-110-BT

- Self centering 3 point heads above 0.250"
- USB connectivity and Bluetooth
- Resolution: 0.00005"/0.001mm
- IP67 rated
- Ratchet stop for consistent measurement
- Sizes over 1 1/25mm offer extended travel
- Includes UKAS certificates for micrometer, heads and settings rings



Contact the Fowler Technical Department for special measuring applications

Order No.	Range	Includes	List Price	Sale Price
54-367-000-BT	0.080" - 0.250"/2 - 6mm (2-point heads)	5 heads, 1 handle, 3 rings	\$5705.05	\$4640.00
54-367-010-BT	0.250" - 0.375"/6 - 10mm	2 heads, 1 handle, 1 ring	2377.11	1930.00
54-367-020-BT	0.375" - 0.750"/10 - 20mm	3 heads, 1 handle, 2 rings	2836.61	2300.00
54-367-050-BT	0.750" - 2" /20 - 50mm	3 heads, 1 handle, 2 rings	3852.18	3130.00
54-367-100-BT	2 - 4"/50 - 100mm	3 heads, 1 handle, 2 rings	4265.00	3465.00
54-367-105-BT	4 - 6"/100 - 150mm	2 heads, 1 handle, 1 ring	3600.68	2925.00
54-367-110-BT	6 - 8" /150 - 200mm	2 heads, 1 handle, 1 ring	4756.33	3865.00
54-367-200-BT	4 - 8" /100 - 200mm	4 heads, 1 handle, 2 rings	7515.47	6110.00
Connectivity Cables/Accessory				
54-115-526-0	Proximity cable with USB connection		\$141.57	\$125.00
54-115-527-0	Proximity cable with serial connection		141.57	125.00
54-115-246-BT	USB bluetooth receiver		50.24	45.00

IMPORTANT: Due to recent tariff increases, prices maybe subject to change.
Prices & Specifications are subject to change without notice.

Fowler® TOOL-A-THON® Vol. 19.1



Find us on social media!



LIFETIME WARRANTY

We are so confident that these Fowler-Sylvac Mark VI electronic indicators are the most accurate, most dependable, best made products you can buy, we are extending the warranty to last a lifetime!

Quality, accuracy, dependability, world-class customer service and now a real Lifetime Warranty!

*No Gimmicks
No Hurdles
No Nonsense*

Mark VI Electronic Indicators

- Robust construction
- Repeatability: 2µm
- Output: Proximity/Power - USB/RS232/digimatic/Wireless
- Menus customizable with free software
- Wide range of functions (MIN/MAX/DELTA, TOL, Factor, Preset, Auto Off, etc)
- Bezel rotates 270°
- Large display with LED tolerance indicators
- Includes lug back



This Button is programmable for common functions

54-530-135-0

NOW
available with
ISO Cert.

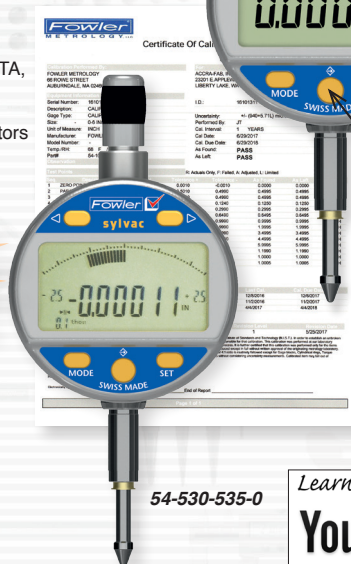

54-530-535-0

Learn more at
YouTube
FowlerVid



Order No.	Description	Maximum Error	Resolution	List Price	Sale Price
54-530-125-0	0 - 0.500"/12.5mm	0.0004"/0.01mm	0.0005"/0.01mm	\$448.16	\$395.00
54-530-135-0	0 - 0.500"/12.5mm	0.00012"/0.003mm	0.00005"/0.001mm	573.85	499.00
54-530-145-0	0 - 1"/25mm	0.0004"/0.01mm	0.0005"/0.01mm	511.50	450.00
54-530-155-0	0 - 1"/25mm	0.00016"/0.004mm	0.00005"/0.001mm	612.11	540.00
54-530-155-C	0 - 1"/25mm with ISO/A2LA Certification				565.00
54-530-175-0	0 - 2"/50mm	0.00019"/0.005mm	0.00005"/0.001mm	\$1158.63	1015.00
Bluetooth					
54-530-335-0	0 - 0.500"/12.5mm	0.00012"/0.003mm	0.00005"/0.001mm	\$710.48	\$620.00
54-530-355-0	0 - 1"/25mm	0.00016"/0.004mm	0.00005"/0.001mm	759.72	665.00
Accessory					
54-115-246-BT	USB Bluetooth Receiver			\$50.24	\$45.00
Analog Display					
54-530-535-0	0 - 0.500"/12.5mm	0.00012"/0.003mm	0.00005"/0.001mm	\$644.90	\$565.00
54-530-555-0	0 - 1.00"/25mm	0.00016"/0.004mm	0.00005"/0.001mm	705.06	615.00

IMPORTANT: Due to recent tariff increases, prices maybe subject to change.
Prices & Specifications are subject to change without notice.

Mark VI Nano Electronic Indicators

- Accuracy: 0.00007"/0.0018mm - 0.5" model
0.00008"/0.0022mm - 1" model
- 0.00001"/0.0001mm resolution
- 0.00002"/0.0005mm repeatability
- Large display
- IP54 rated
- Bluetooth available

LIFETIME WARRANTY



FREE Contact Set!

52-525-065-1, pg. 38

54-530-625-0

Order No.	Description	Accuracy	Resolution	List Price	Sale Price
Without Bluetooth					
54-530-625-0	0.5"/12.5mm	0.00007"/0.0018mm	0.00001"/0.0001mm	\$1082.02	\$950.00
54-530-630-0	1"/25mm	0.00008"/0.0022mm	0.00001"/0.0001mm	1174.61	1030.00
Bluetooth					
54-530-635-0	0.5"/12.5mm	0.00007"/0.0018mm	0.00001"/0.0001mm	\$1289.78	\$1130.00
54-530-640-0	1"/25mm	0.00008"/0.0022mm	0.00001"/0.0001mm	1310.90	1150.00

S_Dial Pro High Accuracy Indicators

- Range: 2"/50mm
- 0.00001"/0.0002mm repeatability
- Mixed ceramic bearing/ball bearing system
- Includes spindle lifting attachment
- IP54 rated
- Available with or without spring tension
- 8mm or 25mm mounting diameter

LIFETIME WARRANTY



54-530-700-0

54-530-705-0

Order No.	Description	List Price	Sale Price
54-530-700-0	8mm mount with spring	\$2759.98	\$2200.00
54-530-705-0	25mm mount with spring	2759.98	2200.00
54-530-710-0	8mm mount without spring	2759.98	2200.00
54-530-715-0	25mm mount without spring	2759.98	2200.00

IMPORTANT: Due to recent tariff increases, prices maybe subject to change.
Prices & Specifications are subject to change without notice.

Fowler
TOOL-A-THON® Vol. 19.1



Find us on social media!

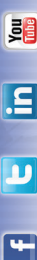

INDI-X^{blue} Electronic Indicators



"Easy to use, easy to read, top notch accuracy"

Mr. R.



54-520-260-0



54-520-250-0



Carbide-tipped point!

INCH • METRIC • FRACTION™

- 2-1/4" dial face
- Lugback and 3/8" stem mountings
- Resolution 0.0005"/0.01mm
- Tolerance function
- Absolute/incremental reading
- Floating zero

Order No.	Description	List Price	Sale Price
54-520-255-0	0.50"/12.5mm Indi-X Blue	\$103.08	\$70.00
54-520-250-0	1"/25mm Indi-X Blue	110.99	75.00
54-520-260-0	1"/25mm/64ths Indi-X Blue Inch-Metric-Fraction	112.61	80.00

Granite Dial Gage Stand

- Sturdy and compact with extreme stability
- 6" x 6" x 2" granite base
- Positive lock screw
- Fine adjustment knob for zero setting
- Column height is 8"
- Accepts all lug-back indicators
- This stand is maintenance free
- Flatness: 0.00005"

Indicator not included with stand



Order No. 52-580-030-0

Sale \$90.00

List \$123.69

IMPORTANT: Due to recent tariff increases, prices maybe subject to change.
Prices & Specifications are subject to change without notice.

INDI-X^{blue}

Small Face Electronic Indicator

- Range: 0 - 0.50"/0 - 12.5mm
- Accuracy: $\pm 0.0008"/0.02\text{mm}$
- Resolution: 0.0005"/0.01mm
- 1.76" dial face
- Carbide tip
- Contains flat and center lug backs
- Includes NIST certification and fitted case



Order No. 54-520-275-0

Sale \$95.00

List \$114.44

INDI-X^{blue}

IP65 HIGH Resolution Electronic Indicator

- Range: 1"/25mm
- Accuracy: $\pm 0.0002"/0.005\text{mm}$
- Resolution: 0.00005"/0.001mm
- IP65 protected
- Carbide tip
- Tolerance function
- Contains flat and center lug backs
- Includes NIST certification and fitted case



Order No. 54-520-270-0

Sale \$125.00

List \$151.90

IP65

INDI-X^{blue}

IP65 Electronic Indicator

- Range: 1"/25mm
- Accuracy: $\pm 0.0012"/0.03\text{mm}$
- IP65 protected
- Carbide tip
- Tolerance function
- Contains flat and center backs
- Includes NIST certification and fitted case



Order No. 54-520-265-0

Sale \$110.00

List \$126.93

IP65

Fowler® TOOL-A-THON® Vol. 19.1



Find us on social media!

IMPORTANT: Due to recent tariff increases, prices maybe subject to change.
Prices & Specifications are subject to change without notice.

Premium Dial Indicators



52-520-135-0



Calibration Certificate
Part Number: 52-520-110-1 Description: Dial Indicator
Serial Number: 61015
Test Standard: ASME B89 Calibration: .001"
Temperature: 20°C
Visual Inspect: Pass

Measure	Pass/Fail
1	P
2	P
3	P
4	P
5	P
6	P
7	P
8	P
9	P
10	P

Gage Block Set
NIST Traceable
11/13-2015
Gage Block Set
0.0010 Serial Number: 1222
Rev: 821/A56789-1
120-6337 internet: www.fowlerprecision.com
www.fowlerprecision.com
1000 Main Street - #1
02460-0001
Newton, Massachusetts 02466

52-520-110-2



52-520-110-1

"Great price for a great indicator" V.C.

- Tolerance markers
- Solid steel housing
- Carbide contact point



Includes NIST Certificate of Calibration

Order No.	Range	Graduation	Reading	Balanced Reading	Dial Color	List Price	Sale Price
52-520-110-1	1"	0.001"	0 - 100	—	Black Face	\$92.91	\$65.00
52-520-110-2	1"	0.001"	0 - 100	—	White Face	92.91	65.00
52-520-105-0	0.500"	0.001"	0 - 100	0 - 50 - 0	White Face	87.88	60.00
52-520-129-0	1"	0.0005"	0 - 50	0 - 25 - 0	White Face	112.36	75.00
52-520-135-0	0.05"	0.0001"	0 - 10	0 - 5 - 0	White Face	161.01	110.00
52-520-125-0	0.250"	0.0005"	0 - 50	0 - 25 - 0	White Face	122.64	82.00

X-PROOF® IP54 Shockproof Dial Indicators

Protection Includes:

- Rubber bellows on stem
- O-ring seal on safety cap
- O-ring protection for bezel and rotating dial
- Sealed back plate

Specifications:

- Shockproof design
- Continuous reading: 0-100
- Tolerance markers
- AGD Group 2, 2-1/4" dia.
- Lugback and carbide point



52-520-450-0



52-520-455-0



Order No.	Range	Graduation	Reading	Contact Point	List Price	Sale Price
52-520-450-0	1"	0.001"	0 - 100	4 - 48 (3/8" stem)	\$78.15	\$65.00
52-520-455-0	1"	0.001"	0 - 100	4 - 48 (3/8" stem)	84.49	65.00

IMPORTANT: Due to recent tariff increases, prices maybe subject to change. Prices & Specifications are subject to change without notice.

XTEST

Horizontal Indicators

- Solid copper body
- Super smooth jeweled movement
- Smoother bezel adjustment for easier zero setting
- 0.080" and 0.120" carbide ball contact points (0.040" steel ball)
- 0.060" range with auto reverse and rev. counter
- Easy to read tilted dial
- 5/32" pivotable stem



Includes NIST Certificate of Calibration

Order No.	Style	Graduations	Dial Diameter	Dial Reading	List Price	Sale Price
52-562-001-0	Horizontal	0.0005"	1-1/2"	0-15-0	\$132.36	\$99.00
52-562-002-0	Horizontal	0.0005"	1"	0-15-0	132.36	99.00
52-562-003-0	Horizontal	0.001"	1"	0-15-0	132.36	99.00
52-562-008-0	Horizontal	0.01mm	38mm	0-40-0	132.59	99.00

XTEST Vertical Indicators

TWICE the range of most indicators!

- Graduations: 0.0005"
- Dial diameter: 1" and dial reading: 0 - 15 - 0
- Solid copper body and super smooth jeweled movement
- Smoother bezel adjustment for easier zero setting
- 0.080" and 0.120" carbide ball contact points (0.040" steel ball)
- 0.060" range with auto reverse and rev. counter
- 5/32" pivotable stem



Includes NIST Certificate of Calibration

Order No.	Style	Graduations	Dial Diameter	Dial Reading	List Price	Sale Price
52-562-004-0	Vertical	0.0005"	1-1/2"	0-15-0	\$144.94	\$99.00
52-562-005-0	Vertical	0.0005"	1"	0-15-0	144.94	99.00
52-562-006-0	Vertical	0.001"	1"	0-15-0	144.94	99.00

XTEST X-Test Indicator & Accessory Combo Kits

Each Combo Kit Includes:

- X-Test Dial Test Indicator
- Axial support
- Height gage bar with clamp
- Adaptor sleeve: 5/32" to 3/8"
- Contact point case
- Contact point wrench
- Complete in shop hardened case



Order No.	Description	Graduations	List Price	Sale Price
52-562-100-0	52-562-001-0 w/accessories	0.0005"	\$194.34	\$140.00
52-562-110-0	52-562-002-0 w/accessories	0.0005"	176.10	130.00
52-562-120-0	52-562-003-0 w/accessories	0.001"	194.34	140.00

IMPORTANT: Due to recent tariff increases, prices maybe subject to change. Prices & Specifications are subject to change without notice.

Fowler TOOL-A-THON® Vol. 19.1



Test Indicator Set with Certificate of Calibration

Test Indicator:

- Auto-reverse
- Jeweled movement
- Range: 0.030"
- Graduation: 0.0005"
- Dial Reading: 0-15-0
- Dial Diameter: 1.125"
- Point length: 0.400"
- Carbide contact points

Set Also Includes:

- 0.080" & 0.040" contact points
- Universal clamp
- Height gage attachment
- 3/8" & 1/4" dovetail clamps
- Manufacturer's test certificate
- Meets ANSI Specs for accuracy
- All in a fitted molded case

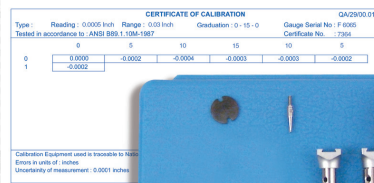

Order No. 52-562-999-0

Sale \$125.00 List \$145.12

Test Indicators

All Fowler Test Indicators include bi-directional constant clockwise rotation, automatic reversal, three dovetail mountings, jeweled movement, two dovetail clamps and a molded case.



Order No.	Face Color	Total Range	Dial Reading	Graduation	Dial Diameter	Point Length	List Price	Sale Price
52-562-774-0	white	0.030"	0-15-0	0.001"	1"	1/2"	\$124.42	\$80.00
52-562-776-0	white	0.030"	0-15-0	0.0005"	1-1/2"	1/2"	138.28	80.00
52-562-780-0	black	0.030"	0-15-0	0.0005"	1-1/2"	1/2"	138.28	80.00



Order No.	Face Color	Total Range	Dial Reading	Graduation	Dial Diameter	Point Length	List Price	Sale Price
52-562-782-0	black	0.020"	0-10-0	0.0005"	1"	1-7/16"	\$136.22	\$85.00
52-562-783-0	white	0.020"	0-10-0	0.0005"	1-1/2"	1-7/16"	136.22	85.00

IMPORTANT: Due to recent tariff increases, prices maybe subject to change. Prices & Specifications are subject to change without notice.

HOLDXTEC[®] Holding Systems

- All accept 3/8" indicators
- Mag base and HOLD-TEC with fine adjust also accepts 8mm indicators
- All have dovetail clamps for test indicators
- Mag base features 2 fine adjusts making it a **6-Axis Mag Base**
- HOLD-TEC can be mounted in drill chucks, collets, dial gage stands with 8mm mount diameter to make a quick transfer stand
- Mag base has 180 lb. pull
- Adjust to any position
- Powerful On/Off mag base
- Central locking system

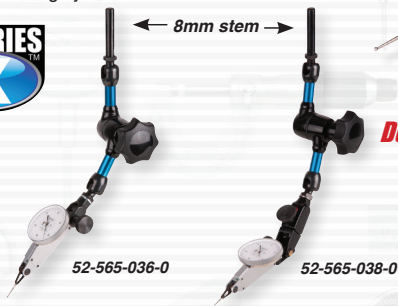

52-565-036-0

52-565-038-0



**Features
Double Fine Adjust**

Indicator not included

52-585-085-0

Order No.	Description	List Price	Sale Price
52-585-085-0	HOLD-Tec Mag Base with Double Fine Adjust	\$165.82	\$95.00
52-565-036-0	HOLD-Tec without Fine Adjust	93.14	62.00
52-565-038-0	HOLD-Tec with Fine Adjust	101.22	65.00

Flex Arm Magnetic Base

- All purpose magnetic base with 180 lbs. of pulling power
- Base can be mounted vertically as well as horizontally
- V-bottom base allows mounting on cylindrical surfaces
- Adjusts to virtually any position

Order No. 52-585-015-0

Sale \$55.00

List \$81.99



Magnetic Base

- 9.5" Height and 85 lb. pull
- Base dimensions are 2" x 2-11/32" x 1-13/16" (50mm x 58.7mm x 46mm)
- Accepts all AGD dial indicators
- V-bottom base allows mounting on cylindrical surfaces
- Mounts test indicators with 1/4" post mount

Order No. 52-585-005-0

Sale \$36.00

List \$52.86



Fowler[®]

TOOL-A-THON[®] Vol. 19.1



Find us on social media!

IMPORTANT: Due to recent tariff increases, prices maybe subject to change.
Prices & Specifications are subject to change without notice.



Premium Depth Micrometers

- Clear microfine graduations on satin chrome finish
- Base constructed of hardened tool steel is precision ground and microlapped. All other surfaces are satin chrome finished.
- Quick and easy zero adjustment
- Rods hardened, ground and lapped on measuring surfaces and adjustable in either direction
- Interchangeable rods are fitted to the micrometer spindle against a positive stop and locked
- Ratchet thimble
- Threads hardened, ground and lapped for accuracy
- Price includes spanner wrench and fitted case



Order No.	Range	Graduation	Accuracy	Base Size	List Price	Sale Price
52-225-005-1	0 - 3"	0.001"	0.0002"	2.5"	\$164.50	\$129.00
52-225-006-1	0 - 4"	0.001"	0.0002"	2.5"	197.42	153.00
52-225-011-1	0 - 4"	0.001"	0.0002"	4"	197.42	153.00
52-225-020-1	0 - 6"	0.001"	0.0002"	2.5"	216.68	165.00
52-225-035-1	0 - 12"	0.001"	0.00028"	4"	350.98	270.00

Economy Depth Micrometers

- Satin chrome finish
- Base surface hardened and ground
- Ratchet thimble
- Locking clamp
- Rod diameter: 0.176"
- Includes case



Order No.	Range	Graduation	Accuracy	Base Size	List Price	Sale Price
52-225-110-0	0 - 0"	0.001"	0.0002"	2.5"	\$137.87	\$115.00
52-225-112-0	0 - 6"	0.001"	0.0002"	2.5"	162.82	135.00
52-225-114-0	0 - 4"	0.001"	0.0002"	4"	148.93	125.00

Digit Counter Depth Micrometers

- Easy-to-read digit counter
- Microfine 0.001" graduations
- 4" base constructed of tool steel, hardened and ground
- Satin chrome finish
- Ratchet thimble
- Locking clamp
- Rod diameter: .176"
- Includes wrench and fitted case

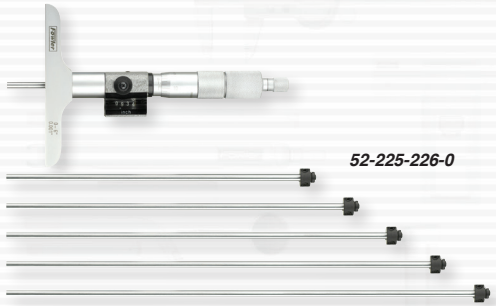

Order No.	Range	Graduation	Base	List Price	Sale Price
52-225-176-0	0 - 6"	0.001"	2.5"	\$197.64	\$155.00
52-225-226-0	0 - 6"	0.001"	4"	204.39	160.00

IMPORTANT: Due to recent tariff increases, prices maybe subject to change.
Prices & Specifications are subject to change without notice.

X-PROOF® 0-22" Dial Depth Gage

with IP54 protection!

BEST VALUE!

IP54 Shockproof indicator available!



- 0-1" AGD Group 2 IP54 Indicator
- Sealed bezel, top cap and dial with bellows on stem
- Sealed back plate
- ± 0.001" accuracy
- 0.001" graduations
- 4" base ground and lapped for flatness
- Rods connect for 22" capacity
- Includes 2 extra points (spline & needle)
- Tolerance markers

Order No. 52-125-007-0

Sale \$99.00

List \$218.56



Depth Base Attachments

- Turn your dial or electronic indicator into a depth gage (may reduce range)
- 4" length
- Fits indicators with 3/8" and 8mm mounting stems
- Ground and lapped base
- Each supplied with 4 extension points, for added application range (4 - 48 thread)
- 52-125-005-0 has 0.430" radius

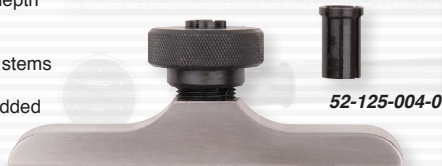

52-125-004-0

Order No.	Description	List Price	Sale Price
52-125-004-0	Flat depth base attachment	\$40.88	\$30.00
52-125-005-0	Radius style depth base attachment	40.88	30.00

Indicator Extensions



NOW Available with Metric Threads!



- Made of stainless steel
- 7 popular sizes
- Stackable for extended lengths
- Available with either inch or metric threads
- Use to extend the contact point of dial indicators

Order No.	Description	List Price	Sale Price
Inch			
52-526-001-0	1", 4 - 48 thread	\$5.02	\$4.00
52-526-002-0	1-1/2", 4 - 48 thread	5.02	4.00
52-526-003-0	2", 4 - 48 thread	6.35	5.00
52-526-004-0	2-1/2", 4 - 48 thread	6.35	5.00
52-526-005-0	3", 4 - 48 thread	6.35	5.00
52-526-006-0	4", 4 - 48 thread	8.81	7.00
52-526-007-0	6", 4 - 48 thread	10.15	8.00
Metric			
52-526-011-0	1", M2.5 thread	\$6.24	\$5.00
52-526-012-0	1-1/2", M2.5 thread	7.28	6.00
52-526-013-0	2", M2.5 thread	7.28	6.50
52-526-014-0	2-1/2", M2.5 thread	7.28	6.50
52-526-015-0	3", M2.5 thread	7.28	6.50
52-526-016-0	4", M2.5 thread	8.32	7.50
52-526-017-0	6", M2.5 thread	10.40	9.00

IMPORTANT: Due to recent tariff increases, prices maybe subject to change. Prices & Specifications are subject to change without notice.

Fowler® TOOL-A-THON® Vol. 19.1



Find us on social media!

f

e

in

YouTube



Indicator Chucks



52-526-020-0

- Low carbon steel, black oxide finished
- 0.140" - 0.040" chucking capacity
- Can be used with small pin gages for special or restricted applications
- Available in both 4 - 48 and M2.5 threads



Indicator shown not included



Order No.	Description	List Price	Sale Price
52-526-020-0	Indicator Chuck with 4 - 48 thread	\$23.93	\$20.00
52-526-021-0	Indicator Chuck with M2.5 thread	23.93	20.00

Indicator Contact Point Set

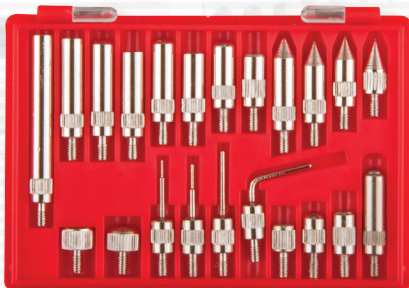

- 22 piece set
- 4-48 thread
- Works with AGD style indicators
- Supplied in fitted case

Order No. 52-525-222-0

Sale \$20.00

List \$39.03

Ruby Contact Point Set

- 6 piece set
- 2 flat contacts
- 2 convex contacts
- 1 extra long contact
- 1 ruby ball contact
- Includes threaded base



Order No. 52-525-065-1

Sale \$16.00

List \$34.10

IMPORTANT: Due to recent tariff increases, prices maybe subject to change.
Prices & Specifications are subject to change without notice.

Inside Micrometers

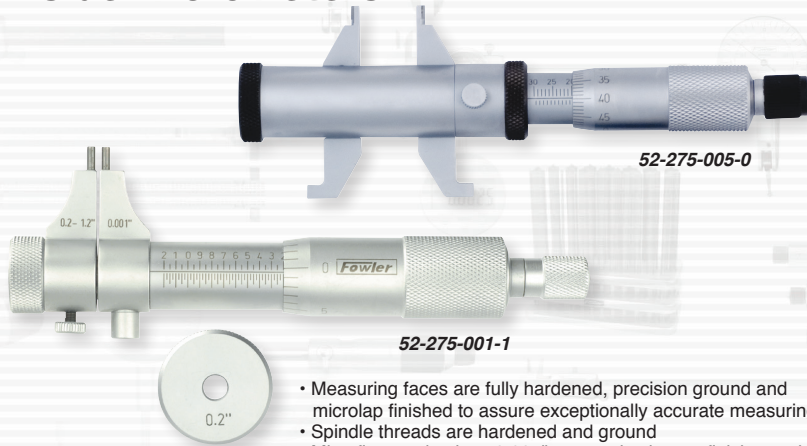

52-275-001-1

- Measuring faces are fully hardened, precision ground and microlap finished to assure exceptionally accurate measuring
- Spindle threads are hardened and ground
- Microfine graduations 0.001" on a satin chrome finish permit easy reading
- Ratchet stop thimble assures exact and repetitive readings
- Includes a setting ring

Order No.	Range	Graduation	Accuracy	List Price	Sale Price
52-275-001-1	0.2" - 1.2"	0.001"	0.0002"	\$116.01	\$85.00
52-275-005-0	0.2" - 2.2"	0.001"	0.0002"	196.12	155.00

Inside Micrometers

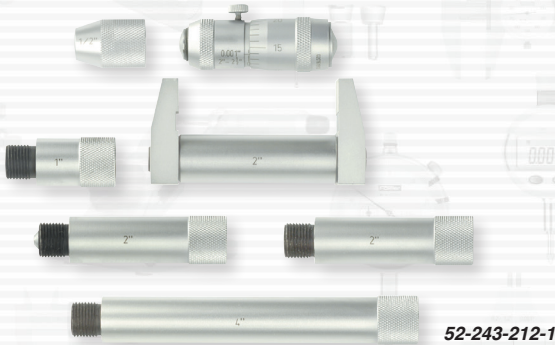

52-243-212-1

- Each set consists of an inside micrometer head and a series of fully hardened and lapped extension rods of different lengths all with carbide measuring faces
- Anvil and spindle are hardened and precision ground with microlap finish on ends
- Microfine graduations on satin chrome
- Positive locking nut on spindle
- It is recommended that the inside micrometer with a rod be calibrated by a micrometer or ring gage.
- Coiled spring pressure contact type rods are each marked with appropriate length.
- Quick, easy zero adjustment on the sleeve.
- Accuracy: $0.00005" \times (3 + L"/2)$
- Graduation: 0.001"
- Includes a wrench, case and reference standard

Order No.	Range	List Price	Sale Price
52-243-026-1	2 - 6"	\$142.63	\$110.00
52-243-212-1	2 - 12"	176.14	135.00
52-243-220-1	2 - 20"	228.32	175.00
52-243-240-1	2 - 40"	603.90	480.00
52-243-480-1	4 - 80"	1273.16	1075.00
52-243-512-1	4 - 120"	2780.61	1960.00

IMPORTANT: Due to recent tariff increases, prices maybe subject to change.
Prices & Specifications are subject to change without notice.





1.4" to 6" Dial Bore Gage Sets

with Carbide Anvils

Industry's two most popular bore gage ranges combined in one set!

Carbide Anvils

- Easy-to-read
- Graduation: 0.0005" or 0.01mm
- Insulated grip
- 1.4" to 6" range or 35 to 160mm



52-646-300-0



XTENDER



52-646-400-0



Order No.	Range	Graduation	List Price	Sale Price
52-646-300-0	2 - 6"	0.0005"	\$129.42	\$110.00
52-646-400-0	1.4 - 6"	0.0005"	196.75	140.00
52-646-500-0	1.4 - 6"	0.0001"	246.55	180.00
52-646-220-0	35 - 60mm	0.01mm	217.41	140.00
Extensions				
52-646-450-0	20" depth extension		\$84.89	\$75.00
52-646-475-0	40" depth extension		106.12	95.00

XTENDER Electronic Bore Gage Set

with Carbide Anvils

Industry's two most popular bore gage ranges combined in one easy-to-use electronic set!

Preset size of master for absolute reading and use minimum hold feature to lock on the bore size as the gage is rocked in the part to be measured.



Bore Gage features:

- Range: 1.4"-6"/35mm-150mm
- Carbide anvils
- Self-centering

Indicator features:

- Bar graph and numeric digital display
- Preset with recall
- ABS/INC measurement
- Min/Max/TIR



Order No.	Range	Resolution	List Price	Sale Price
54-646-401-0	1.4 - 6"/35 - 150mm	0.00005"/0.001mm	\$339.94	\$255.00
Extensions				
52-646-450-0	20" depth extension		\$84.89	\$75.00
52-646-475-0	40" depth extension		106.12	95.00

IMPORTANT: Due to recent tariff increases, prices maybe subject to change.
Prices & Specifications are subject to change without notice.

XTENDER-E

PLUS+

Bore Gage Set

- Fitted with a Sylvac Lifetime Warranty electronic indicator (54-530-535-0)
- Range: 1.4 - 6" - 6"
- Analog scale for reversal point detection
- IP54 rated indicator
- Carbide tipped anvils
- Min/Max/TIR readings
- Supplied in a fitted case



Protected to:
IP54
COOLANT & FLUID
RESISTANT



Order No.	Range	Resolution	List Price	Sale Price
54-646-535-0	1.4 - 6"/35 - 150mm	0.00005"/0.001mm	\$800.70	\$710.00
Extensions				
52-646-450-0	20" depth extension		\$84.89	\$75.00
52-646-475-0	40" depth extension		106.12	95.00
Connectivity Cables				
54-115-526-0	Proximity cable with USB connection		\$141.57	\$125.00
54-115-527-0	Proximity cable with serial connection		141.57	125.00

Bore Gage Setting Master Kits - Inch & Metric

Fowler's Bore Gage Setting Master Kit is used for accurately setting any bore gage up to 6"/150mm in diameter to an accuracy of 0.0001"/0.003mm

Each Set includes:

Setting Device (53-646-000-1 - Inch Model)

- Base anvil: 3.950" x 1.050"
- Adjustable anvil 2.375" x .375" (two each)
- Internal capacity: 6"/150mm
- Depth capacity: 1"/25mm
- Centralizer capacity width: 2.750"
- Quick-release holder for fast adjustment
- **Can also be used for external setting, depending on application (external mics, snap gages, caliper gages)**

Economy Gage Block Sets

Inch model:

- 36 piece
- Tolerances to .00005"
- Certificate of Calibration to NIST

Metric model:

- 33 piece
- AS-2 grade
- Certificate of Calibration to NIST

Includes:
Bore gage setting master
and gage block set.
All in a custom-fitted
case!

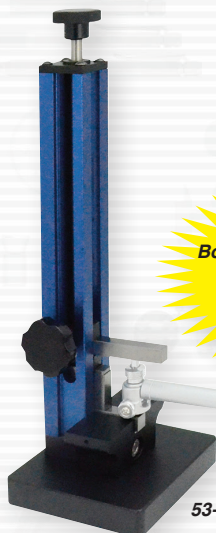

53-646-000-1



Order No.	Description	List Price	Sale Price
53-646-000-1	Inch Bore Gage Setting Master Kit	\$315.68	\$225.00
53-646-010-0	Metric Bore Gage Setting Master Kit	328.95	235.00
53-646-005-0	Bore Gage Setting Master Kit - without Gage Blocks	182.07	160.00

IMPORTANT: Due to recent tariff increases, prices maybe subject to change.
Prices & Specifications are subject to change without notice.

Fowler®

TOOL-A-THON®

Vol. 19.1



Find us on social media!



XTRA-VALUE Bore Mics

3-Point Bore Gage Micrometers



52-257-103-0



- 3 point self-centering measuring heads
- Carbide tipped anvils
- Ratchet stop, satin chrome thimble
- 0.0001" graduations up to 0.50"
- 0.0002" graduations above 0.50"
- Sizes below 0.50" includes 4" extension
- Sizes above 0.50" includes 6" extension
- Each set includes setting ring and fitted aluminum case
- Sizes below 0.50" read 0.060" from bottom of head
- Sizes above 0.50" read 0.020" from bottom of head



52-257-007-0



Order No.	Range	Accuracy	List Price	Sale Price
52-257-001-0	NEW 0.275" - 0.350"	0.00016"	\$327.73	\$290.00
52-257-002-0	NEW 0.350" - 0.425"	0.00016"	327.73	290.00
52-257-003-0	NEW 0.425" - 0.500"	0.00016"	327.73	290.00
52-257-004-0	NEW 0.500" - 0.650"	0.00016"	223.69	200.00
52-257-005-0	NEW 0.650" - 0.800"	0.00016"	223.69	200.00
52-257-006-0	NEW 0.800" - 1.000"	0.00016"	312.12	280.00
52-257-007-0	NEW 1" - 1.2"	0.00016"	312.12	280.00
52-257-008-0	NEW 1.2" - 1.6"	0.00016"	338.13	300.00
52-257-009-0	NEW 1.6" - 2"	0.0002"	390.15	350.00
52-257-010-0	NEW 2" - 2.5"	0.0002"	410.96	365.00
52-257-011-0	NEW 2.5" - 3"	0.0002"	442.17	395.00
52-257-012-0	NEW 3" - 3.5"	0.0002"	457.78	410.00
52-257-013-0	NEW 3.5" - 4"	0.0002"	483.79	435.00
Sets				
52-257-101-0	NEW 0.275" - 0.500"		\$889.54	\$800.00
52-257-102-0	NEW 0.500" - 0.800"		395.35	355.00
52-257-103-0	NEW 0.800" - 2"		1123.63	1010.00
52-257-104-0	NEW 2" - 4"		1477.37	1325.00

IMPORTANT: Due to recent tariff increases, prices maybe subject to change. Prices & Specifications are subject to change without notice.

Digi Level **PLUS+**

NEW!

- Super large 18mm backlit display
- Bluetooth model available
- Includes a 6" graduated, beveled straight edge **PLUS**, see page 44
- Rechargeable battery
- USB charging cable supplied
- V's on top and bottom for measuring on cylindrical surfaces
- Embedded magnets on bottom base
- IP65 rated
- Auto inverting display



IP65

54-422-550-0

Order No.	Description	List Price	Sale Price
54-422-550-0	NEW Digi-Level PLUS	\$125.51	\$110.00
54-422-550-BT	NEW Digi-Level PLUS with Bluetooth	141.88	125.00

mini-MAG Protractor™

The mini-MAG Protractor provides instant 360° digital inclination display of any angle with the additional unique feature of embedded magnets on both sides and the bottom which make it ideal for a variety of measurements.

- Embedded magnets with 3.5lb. pull
- Uses standard 9V battery (250 hrs.)
- Measuring range: 360° (4 x 90°)
- Display automatically inverts
- Resolution: 0.05°
- Accuracy: ± 0.2°
- Repeatability: 0.05°
- Dimensions 2.375" x 1.375" x 2.375"
- Hold feature



Display inverts for easy reading!



54-422-450-1

NEW!

54-422-460-0

- On/off, tilt %, light, zero functions
- Display is backlit for low light areas



Order No.	Description	List Price	Sale Price
54-422-450-1	mini-MAG protractor	\$105.72	\$60.00
54-422-460-0	NEW mini-MAG II protractor	111.18	65.00

mini-MAG PLUS

The Mini-Mag PLUS Protractor features a USB rechargeable battery, a backlit display, Tilt% function and IP54 protection against water, oil, and fluids.

- 6 month battery life
- Auto off after 5 minutes
- Embedded magnets
- Measuring range: 360° (4 x 90)
- Display automatically inverts
- Resolution: 0.05°
- Accuracy: ± 0.2°
- Repeatability: 0.05°
- Hold feature
- Zero function
- Smaller size: 2.12" x 2.12" x .9"



Order No. 54-422-500-0

Sale \$75.00

List \$116.89



Find us on social media!

IMPORTANT: Due to recent tariff increases, prices maybe subject to change. Prices & Specifications are subject to change without notice.



Straight Edges **PLUS+**

NEW!

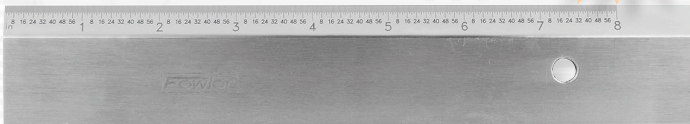

- Beveled edge with 1/64th graduations
- Satin chrome finish on scale
- Hardened steel
- 0.21" thick, 1.59" wide
- Storage sleeve included

52-480-070-0

Order No.	Description	Straightness	List Price	Sale Price
52-480-065-0	NEW 6"	0.0015"	\$22.92	\$19.00
52-480-070-0	NEW 8"	0.0015"	28.38	24.00
52-480-075-0	NEW 12"	0.0015"	41.47	35.00
52-480-080-0	NEW 24"	0.0025"	63.30	53.00

Cylindrical Squares

- Used for checking squares, height gages and other instruments
- Hardened and the ends are lapped to 90° angular accuracy
- 6" cylindrical squares: ± 0.0001 "
- 12" cylindrical square: ± 0.00015 "
- Includes handles and wood case

52-750-012-0



52-750-006-0

Order No.	Description	List Price	Sale Price
52-750-006-0	6" cylindrical square	\$200.91	\$165.00
52-750-012-0	12" cylindrical square	286.94	240.00

Steel Squares & Sets



52-432-246-0



- Made of the finest carbon tool steel, these economy squares have true right angles both inside and outside
- Beams and blades ground and lapped for straightness and parallelism
- Hardened blade
- Beam grooved at inner corner for clearance of burrs and dirt
- Squareness of blade edge to the working face: 2" & 3" = ± 0.0006 ", 4" & 6" = ± 0.0008 ", 9" & 12" = ± 0.0012 "

Sets come complete in a "Shop Hardened" molded case!

Blade Size	Beam Size
2"	1.5"
3"	2.5"
4"	3"
6"	4"
9"	6"
12"	8"

Order No.	Size/Description	List Price	Sale Price
52-432-444-0	3 Piece Square Set: 2", 4" & 6" with shop hardened case	\$75.01	\$66.00
52-432-469-0	4 Piece Square Set: 4", 6", 9" & 12" with shop hardened case	176.03	155.00
52-432-004-0	4" Square only	23.50	20.00
52-432-006-0	6" Square only	26.12	23.00
52-432-009-0	9" Square only	60.13	51.00
52-432-012-0	12" Square only	113.12	96.00

IMPORTANT: Due to recent tariff increases, prices maybe subject to change.
Prices & Specifications are subject to change without notice.

Combination Square

- Blades are chrome plated, fully hardened and tempered
- Includes square, protractor and center head with 12" blade
- Square head has level and scriber point
- Double indexed protractor is graduated 180° in both directions
- Graduated in 8ths, 16ths, 32nds and 64ths



"Good instrument, good price."
R.L.

Order No. 52-370-012-0

Sale \$165.00

List \$212.85

Rules

52-297-006-0

EZ-Read Black Face Rules

- Hardened stainless steel
- White easy-to-read microfine graduations against a black, non-glare finish



52-330-006-0

Satin Chrome Rules

- Tempered steel
- Non-glare
- Sharp, easy-to-read microfine graduations



GRADUATIONS
4R: 8ths, 16ths, 32nds, 64ths
16R: 32nds, 64ths, 50ths, 100ths

RIGID STEEL RULES

Order No.	Finish	Size	Reading	List Price	Sale Price
52-330-006-0	Satin Chrome	6"	4R	\$14.46	\$12.50
52-337-006-0	Black	6"	4R	11.55	10.50
52-330-012-0	Satin Chrome	12"	4R	24.77	22.00
52-337-012-0	Black	12"	4R	22.27	19.00
52-350-006-0	Satin Chrome	6"	16R	12.17	10.50
52-338-006-0	Black	6"	16R	11.55	10.50
52-350-012-0	Satin Chrome	12"	16R	24.61	20.00
52-338-012-0	Black	12"	16R	19.67	15.50

FLEXIBLE STEEL RULES

Order No.	Finish	Size	Reading	List Price	Sale Price
52-295-006-0	Satin Chrome	6"	4R	\$11.99	\$10.50
52-297-006-0	Black	6"	4R	10.82	9.50
52-295-012-0	Satin Chrome	12"	4R	21.65	19.00
52-297-012-0	Black	12"	4R	17.48	15.50
52-308-006-0	Black	6"	16R	10.51	9.50
52-310-006-0	Satin Chrome	6"	16R	12.38	10.50
52-308-012-0	Black	12"	16R	17.48	15.50
52-310-012-0	Satin Chrome	12"	16R	21.95	20.00

Carbide Super Scriber



- Lightweight
- Retractable carbide tip
- Knurled grip
- Machined aluminum body
- Pocket clip

Order No.	Description	Overall Length	List Price	Sale Price
52-500-050-0	Carbide Super Scriber	6.5"	\$35.66	\$28.50
52-500-055-0	Carbide Refill		10.92	9.50

IMPORTANT: Due to recent tariff increases, prices maybe subject to change.
 Prices & Specifications are subject to change without notice.

Fowler® TOOL-A-THON® Vol. 19.1



Find us on social media!
 f
 E
 in
 You Tube



SHOP-BLOX®

Economy Rectangular Gage Block Sets



"Perfect for small shops. A really great bang for the buck"
M.L.L.



53-672-081-0

- Manufactured to meet Federal Specification ASME B89. 1.9 - 2002 tolerances on length for inch gage blocks
- Certificate of Calibration traceable to NIST
- Tolerances to $\pm 0.00005''$
- In high-quality fitted wood case

Order No.	Description	List Price	Sale Price
53-672-036-0	36 piece Economy Rectangular Gage Block Set	\$321.68	\$215.00
53-672-081-0	81 piece Economy Rectangular Gage Block Set	550.18	395.00

QUICK CHECK Multi-Function Check Standard

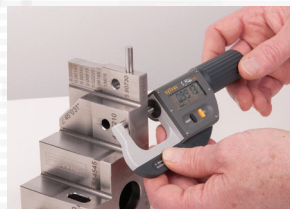

- Accuracy of indicated values $\pm 0.003\text{mm}$
- One compact, multi-function, precise standard
- Can be used to check and verify a multitude of measuring instruments
- Check height gages, calipers, micrometers, depth gages, bore gages, test and dial indicators, caliper gages, protractors, and more ...
- Supplied with a manufacturer's test certificate and fitted wood case
- All sizes marked are actual

Order No. 53-813-015-0

Sale \$1320.00

List \$1677.49

IMPORTANT: Due to recent tariff increases, prices maybe subject to change.
Prices & Specifications are subject to change without notice.

Telescoping Gage Sets

Another great tool for easy and accurate measurements. Under spring tension, the plungers of the gage expand from the center to the size of the hole being measured and are then locked in place using the knurled knob. Final hole size is obtained by measuring over the contacts with a micrometer or vernier caliper.

- Contact points are constructed of hardened tool steel, precision ground.
- Double action rigid handle with self-centering feature for quick checking of inside measurements
- Constant spring tension for uniform feel
- **52-470-006-0 covers a measuring range of 5/16" to 6" with measurable depths of 4" to 5"**
- **52-470-007-0 covers a measuring range of 5/16" to 6" with measurable depths of 12"**
- **52-470-000-0 Titanium Coated, 5/16" to 6" with measurable depths of 4" to 5"**
- Includes fitted vinyl case

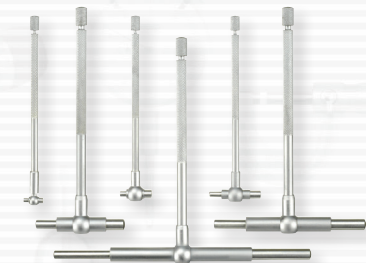

52-470-006-0



12" Reach!

52-470-007-0



**Titanium Coated
for added wear protection!**

52-470-000-0

Order No.	Description	List Price	Sale Price
52-470-006-0	6" Telescoping Gage Set	\$110.20	\$75.00
52-470-007-0	12" Telescoping Gage Set	132.70	110.00
52-470-000-0	Titanium coated 6" Telescoping Gage Set	123.73	95.00

Screw Pitch Gages

- Narrow designed blades permit use for internal and external screw threads
- Locking device at each end to secure all blades for storage or position
- Correct pitch is determined by matching blade teeth with threads
- Precisely ground and finished
- Blades marked with thread size



52-485-015-0

Order No.	Description	List Price	Sale Price
Inch Series			
52-485-015-0	Screw Pitch Gage with 30 blades: 4 to 42 pitch standard V thread	\$12.04	\$10.00
Metric Series			
52-485-020-0	Screw Pitch Gage with 24 blades: 0.25mm to 6.0mm	12.04	10.00

IMPORTANT: Due to recent tariff increases, prices maybe subject to change.
Prices & Specifications are subject to change without notice.

Fowler
TOOL-A-THON® Vol. 19.1



Find us on social media!



1-2-3, 2-3-4 & 2-4-6 Blocks

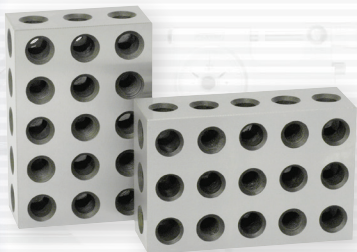

52-439-234-0

- 23 holes for easy clamping
- 52-439-001-0 features one hole only
- Sold in pairs
- Hardened 56 - 60 HRC
- Useful in layout & grinding work

Order No.	Description	Accuracy	List Price	Sale Price
52-439-001-0	1-2-3 Blocks	± 0.0002"/1"	\$145.59	\$99.00
52-439-234-0	2-3-4 Blocks	± 0.0001"/1"	96.90	85.00
52-439-246-0	2-4-6 Blocks	± 0.0003"/1"	224.62	130.00

X-BLOX® V-Block Set



2 each @:

- Dimensions: 1-1/2" L x 1-1/4" W x 1-1/4" H
- Work capacity: Approximately 1"

2 each @:

- Dimensions: 2" L x 1-1/2" W x 1-1/2" H
- Work capacity: 1-1/2"

All feature:

- Surfaces are square and parallel within 0.0005"
- V-grooves are square and parallel with all surfaces within 0.0005"
- Corresponding dimensions for each pair are alike within 0.0005"



"You will not go wrong buying this product"

J.B

Order No. 52-475-500-0

Sale \$120.00

List \$136.39

Parallel Sets

- 1/2", 5/8", 3/4", 7/8", 1", 1-1/8", 1-1/4", 1-3/8", 1-1/2" & 1-5/8" heights
- 6" in length
- Height specifications relate to consistency within each pair. Absolute heights are nominal
- Hardness: 50 HRC, 6" length and 1/32" thickness
- Includes fitted case



52-437-000-0



52-437-031-0

Order No.	Parallelism	Paired Height	List Price	Sale Price
52-437-031-0	± 0.0001"	± 0.0001"	\$251.50	\$190.00
52-437-000-0	± 0.0002"	± 0.001"	243.03	180.00

IMPORTANT: Due to recent tariff increases, prices maybe subject to change.
 Prices & Specifications are subject to change without notice.

Electronic Edge Finders

- Six equally spaced light ports provide visibility at any angle
- Made in the USA
- Edge finder lights instantly when stylus touches work edge
- Repeatability: 0.0002"
- Works on any conductive metal



Along with light indication, model #54-575-650-0 emits an audible "beep" at time of contact.

Order No.	Stylus	Shank	Audible	Battery	List Price	Sale Price
54-575-600-0	0.200"	1/2"	NO	12 volt	\$37.54	\$32.00
54-575-625-0	0.200"	1/2"	NO	12 volt	138.52	115.00
54-575-650-0	0.400"	3/4"	YES	12 volt	138.52	115.00

Transfer Punch Sets

- Punches are made of hardened and tempered tool steel, black oxide finished
- All sizes are marked and diameters are slightly undersized for easy handling
- Set supplied with index stand



52-482-028-0

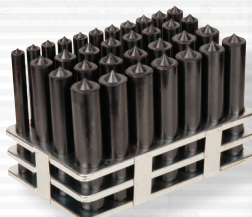

52-482-030-0

Order No.	Description	Range	List Price	Sale Price
52-482-028-0	28 pc. Transfer Punch Set	3/32" to 1/2"	\$54.55	\$35.00
52-482-030-0	33 pc. Transfer Punch Set	1/2" to 1"	94.82	75.00

4 Piece Deburring Cutter Set



- Colored sleeves rotate to lock and unlock blades for easy changing
- Unique rounded head blades for safe deburring of drilled and machined holes, end milled areas, tubing, backside of holes and an almost unlimited amount of uses
- Curved blades swivel freely to automatically follow shapes, contours and holes

Order No. 52-483-777-0

Sale \$12.00

List \$16.50

IMPORTANT: Due to recent tariff increases, prices maybe subject to change.
Prices & Specifications are subject to change without notice.

Fowler®

TOOL-A-THON® Vol. 19.1



Find us on social media!

Dave's Special Deals!

* limited quantities

Electronic Inside/Outside Gage

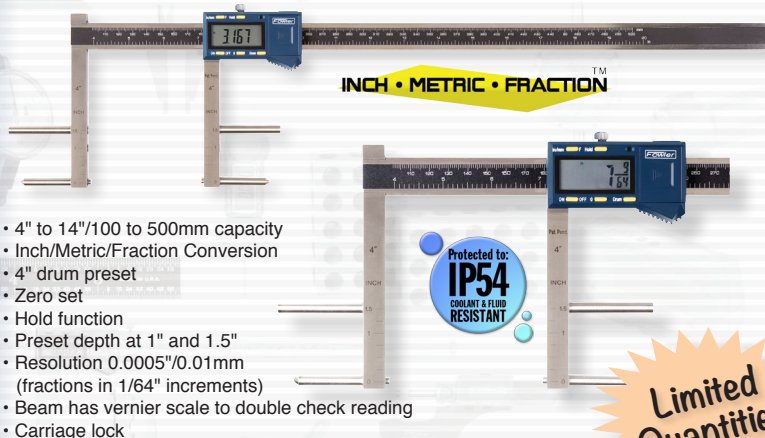

- 4" to 14"/100 to 500mm capacity
- Inch/Metric/Fraction Conversion
- 4" drum preset
- Zero set
- Hold function
- Preset depth at 1" and 1.5"
- Resolution 0.0005"/0.01mm (fractions in 1/64" increments)
- Beam has vernier scale to double check reading
- Carriage lock

Order No. 54-150-014-0

Sale \$80.00 List \$163.71

UltraTast Horizontal Test Indicators



Limited Quantities

- Box-type housing opens on one side only
- Bottom and side walls are one piece construction which encloses and protects the movement from shocks and damage
- Self-contained movement
- Jeweled movement bearings, precision gears and pinions for maximum sensitivity and accuracy
- Satin-chrome finish is corrosion proof
- Stylus: ball diameter 0.080"/2mm
- Swivel range 220° on all models
- Includes 1/4" & 5/16" Dovetail clamps



Order No.	Reading	Measuring Range	Dial Diameter	Stylus Length	Measuring Force
52-568-010-0	0.0005"	± 0.015"	1.50"	0.453"	0.15N
52-568-022-0	0.0005"	± 0.015"	1.083"	1.417"	0.07N

Order No.	List Price	Sale Price
52-568-010-0	\$144.43	\$75.00
52-568-022-0	206.86	99.00

IMPORTANT: Due to recent tariff increases, prices maybe subject to change. Prices & Specifications are subject to change without notice.

Dave's Special Deals!

* limited quantities



Electronic IP54 Outside Micrometer Set

Limited Quantities



- Range: 0 - 4" / 0 - 100mm
- Large easy-to-read LCD display
- Automatic switch off
- Friction thimble
- Protected to IP54 specifications
- Insulated frames
- Supplied with standards, case and wrench

Order No. 54-860-104-0

Sale \$300.00

List \$679.22

12" Hook Rule

Limited Quantities

Front

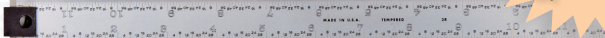

Back



- Made of tempered, hardened steel
- Finished in non-glare satin chrome
- Rule Thickness: 0.040"
- All hook rules are rigid
- 4R graduations (8ths, 16ths, 32nds & 64ths)
- Sharp black graduations
- Adjustable, removable hooks
- Fitted in clear plastic case

Order No. 52-360-812-0

Sale \$15.00

List \$31.72

IMPORTANT: Due to recent tariff increases, prices maybe subject to change. Prices & Specifications are subject to change without notice.



Find us on social media!



HIGH PRECISION
www.fowlerprecision.com