



HIGH PRECISION

TOOL-A-THON®



Volume 23.3 Valid Sept. 1st - Dec. 31st

www.fowlerprecision.com

Fowler continues to introduce innovations in inspection and measurement with new highly engineered systems designed to increase accuracy, decrease measurement time, and automate record keeping.

We offer solutions for all your measurement challenges. Call us today with your measurement needs, 1-800-788-2353

www.fowlerprecision.com

NEW Fulcrum

Revolutionary Manual CMM

Features

- Shop floor, bench top, manual CMM for measurements right next to your machine tools
- Includes monitor with built-in PC equipped with Fowler FUSION 3D Metrology Software
- Advanced GD&T capabilities
- Simple, quick feature check/dimensioning
- Program routines can be played back manually for automatic dimensioning and instant reporting
- 280mm x 280mm x 150mm XYZ measuring range
- 0.0002"/0.005mm volumetric accuracy
- Simple, single USB connection to PC and requires no air

Fowler FUSION
Metrology Software

Order No. 54-960-400-0



Mark 1 CMM

Features:

- Shop floor hardened for use at the machine center
- Compact open frame design, perfect for automation
- Easy to use FUSION Software
- Robust enough to use around the clock
- 5 temp. sensors allow for use in uncontrolled environments

Fowler FUSION
Metrology Software

Order No.	Description
MK1-EXT-370	(XY) 370mm x (Z) 270mm
MK1-EXT-520	(XY) 520mm x (Z) 300mm

zCAT Portable CMM

Features:

- Compact for use at the machine center
- Easy to use FUSION Software
- Completely portable, only 30 lbs.
- High accuracy
- Ethernet communication (Bluetooth optional)

Fowler FUSION
Metrology Software



Order No. 54-950-001-0

Horizontal Setting and Calibration

Setting and measuring equipment.

THV Horizontal



Order No. 54-198-558-0

Features:

- For the calibration of rings, plugs, thread gages and various gages up to 4"
- Small, portable, versatile and accurate
- Ultra precise to 0.000016"
- Meets ISO 9000 requirements

HS6

Features:

- For setting equipment with variable dimensions quickly and accurately
- Available in sizes up to 120"
- Large selection of accessories to handle any job



Order No. 54-196-900-5

NEW Rapid Measuring Systems

Features:

- Simultaneous measuring up to 100 parts
- Simple place and press measurement finishes in 3 seconds
- No more operator errors
- Powerful yet easy to use measuring software
- 4"/100mm Field of View
- Measuring range up to 12" x 8"/300mm x 200mm
- High resolution: 0.00004"/0.0001mm



Measures multiple parts simultaneously



One touch measuring



- ✓ Place your parts
- ✓ Press the button
- ✓ See the results in seconds

Model No.	Measuring Range
54-830-310-0	100mm x 200mm
54-830-320-0	200mm x 200mm
54-830-830-0	300mm x 200mm

Order No. 54-830-830-0

Call for more information, 1-800-788-2353!

Venture 3030 XT Multi-Sensor Vision System

Features:

- 4 in 1 measuring system
 - Non-contact camera system
 - TP20 or SP25 CMM probing
 - Standard optical comparator functions
 - Digital microscope capabilities
- Simple, teach & repeat programming
- 300mm x 300mm x 200mm XYZ measuring range
- High resolution 0.5µm scales



Fowler FUSION
Metrology Software

Order No. 54-242-000-0

Discovery Kit

Discover the benefits of the wireless connectivity!



23.3

FREE
with the purchase of ANY
NEW Sylvac SCAN
(Excluding trade-ins)



Includes:

- 1 caliper, 1 digital indicator, 1 micrometer and 1 test indicator. ALL with Bluetooth® Technology
- Sylvac PRO Software (Smart dongle included)
- Accessory for battery change

over \$5,000 value

The BEST Solution for Shaft Scanning!

Increase productivity while reducing scrap and inspection cycle times by a factor of 10.

Features:

- Measuring Range:
 - Diameters from 0.5mm up to 145mm
 - Lengths from 0.5mm up to 1800mm
- Accuracy:
 - Diametric starting at 0.9µm
 - Linear starting at 2.5µm
- AUTO part/feature measuring
- AUTO program recognition
- AUTO-mation ready



Thread Measurement
Exclusive helix tilting system
for more comprehensive
thread measurements



ONE Click Measurement

SCAN S145



54-902-145-5

SCAN F60



54-902-406-5

SCAN S25



54-902-025-5

Systems



Prices & Specifications are subject to change without notice.

Swiss Ultra-Cal VI Digital Calipers

3 styles to suit your needs.



54-100-167-0



54-100-444-1



Features:

- IP67 protected against fluid and dust
- Available with Bluetooth, proximity cable or no SPC output
- Heavy duty frame
- Extra large display
- Available with ISO Cert
- 12"/300mm is supplied without depth rod

 **sylvac**

 **SWISS PRECISION**



Calibration certificates available for all sizes.

Order No.	Range	Accuracy	Resolution	List Price	Sale Price
Bluetooth Communication					
54-100-167-0	6"/150mm	0.0008"/20µm	0.0005"/0.01mm	\$447.45	\$393.59
54-100-168-0	8"/200mm	0.0012"/30µm	0.0005"/0.01mm	\$725.47	\$638.15
54-100-169-0	12"/300mm	0.0012"/30µm	0.0005"/0.01mm	\$966.63	\$795.60
Proximity Cable Communication					
54-100-444-1	6"/150mm	0.0008"/20µm	0.0005"/0.01mm	\$206.38	\$186.72
54-100-448-1	8"/200mm	0.0012"/30µm	0.0005"/0.01mm	\$426.88	\$386.21
54-100-412-1	12"/300mm	0.0012"/30µm	0.0005"/0.01mm	\$575.78	\$520.95
Without Data Output					
54-100-177-0	6"/150mm	0.0008"/20µm	0.0005"/0.01mm	\$188.62	\$170.65
54-100-178-0	8"/200mm	0.0012"/30µm	0.0005"/0.01mm	\$387.17	\$350.29
54-100-179-0	12"/300mm	0.0012"/30µm	0.0005"/0.01mm	\$511.18	\$462.49
Connectivity Cables/Accessories					
54-981-713-2	Sylcom Basic Data Processing Software			\$900.76	\$830.96
54-115-246-BT	USB bluetooth receiver			\$54.94	\$47.17
54-115-526-0	Proximity cable with USB connection			\$223.37	\$203.27
54-115-527-0	Proximity cable with serial connection			\$227.67	\$207.18

XTRA-VALUE CAL Digital Calipers

Value priced verniers.

23.3



54-101-150-2



54-101-300-1



Features:

- Stainless steel frame
- Large easy-to-read display
- Resolution: 0.0005"/0.01mm
- Absolute/Incremental measurement
- 4-way measuring, inside, outside, depth and step
- 6" and 12" regular display models include NIST Cert.
- Includes fitted case

Order No.	Range	Accuracy	List Price	Sale Price
54-101-150-2	6"/150mm - Regular Display	0.001"/0.02mm	\$61.03	\$55.54
54-101-600-1	6"/150mm - Large Display with Hold feature	0.0015"/0.04mm	\$79.59	\$71.63
54-101-200-1	8"/200mm - Regular Display	0.0015"/0.04mm	\$98.37	\$88.00
54-101-300-1	12"/300mm - Regular Display	0.0015"/0.04mm	\$121.82	\$109.18
54-101-900-1	12"/300mm - Large Display with Hold feature	0.0015"/0.04mm	\$159.18	\$143.00

Calipers

XTRA-VALUE Plus Digital Caliper

IP54 protected with inch/metric/fractions.



Features:

- Range: 6"/150mm
- Accuracy: $\pm 0.001"/0.02mm$
- Inch/Metric/Fraction reading: 0.0005"/0.01mm/ 1/128"
- Heavy Duty frame for extra rigidity and wear resistance
- Super large, easy to read display
- Includes fitted case, calibration standard and spare battery tray

Order No. 54-103-006-0

Sale \$82.40

List Price \$95.17



IP67 Digital Calipers

Smart Wireless Communication to most phones or tablets.



54-100-556-BT

Features:

- IP67 protected against fluid and dust
- Wireless connectivity for quick error free data collection
- Supplied with NIST certification
- Heavy duty frame with 4-way measuring, inside, outside, depth and step
- Super large display
- Includes fitted case, extra battery tray and a 1" setting standard

Order No.	Range	Accuracy	List Price	Sale Price
54-100-554-BT	0 - 4"/100mm	0.001"/0.02mm	\$216.28	\$196.81
54-100-556-BT	0 - 6"/150mm	0.001"/0.02mm	\$222.35	\$200.85
54-100-512-BT	0 - 12"/300mm	0.0015"/0.04mm	\$288.37	\$262.65

Digital Calipers

Absolute location retention after shut off.



54-100-000-2

Features:

- Resolution: 0.0005"/0.01mm
- Absolute/Incremental Measurement
- Stainless steel frame
- Direct Inch/Metric conversion
- 4-way measuring, inside, outside, depth and step
- Wireless SPC data option
- Includes fitted case

Order No.	Range	Accuracy	List Price	Sale Price
54-100-004-2	4"/100mm	0.001"/0.02mm	\$137.73	\$123.96
54-100-000-2	6"/150mm	0.001"/0.02mm	\$155.73	\$140.15
54-100-008-2	8"/200mm	0.0015"/0.04mm	\$182.85	\$164.56
54-100-112-2	12"/300mm	0.0015"/0.04mm	\$238.40	\$214.56
Accessories				
54-115-100-0	Wireless transmitter		\$133.12	\$123.80

Premium Grade Dial Calipers

With mono-block housing for added protection.



52-008-706-0

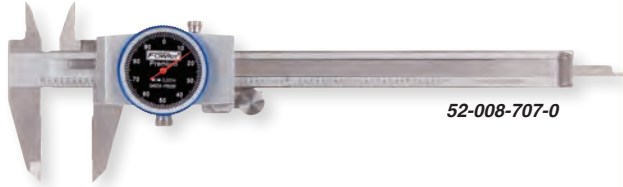

52-008-707-0

Features:

- Tough shockproof gearing with ultra smooth movement
- 4-way measuring, inside, outside, depth and step
- Inverted/covered rack
- Solid stainless steel construction with lapped measuring faces
- 0.100" range per revolution
- 0.001" reading dial

Order No.	Range	Dial Color	Accuracy	List Price	Sale Price
52-008-706-0	0 - 6"	White	± 0.001"	\$102.74	\$91.67
52-008-707-0	0 - 6"	Black	± 0.001"	\$102.74	\$91.67
52-008-708-0	0 - 8"	White	± 0.0015"	\$123.37	\$112.27
52-008-712-0	0 - 12"	White	± 0.002"	\$165.88	\$147.29
Metric					
52-008-709-0	0 - 150mm	Yellow	± 0.02mm	\$105.93	\$95.33

Dial Calipers



52-008-005-1

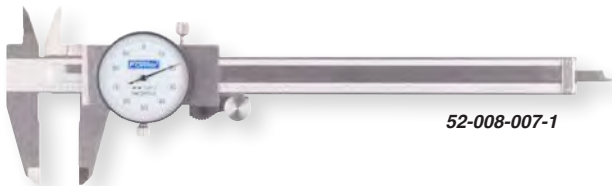

52-008-007-1

Features:

- 4-way measuring for outside, inside, depths and steps
- Graduation: 0.001"
- Hardened stainless steel throughout
- Covered rack
- Shockproof gearing

Order No.	Range	Dial Color	Accuracy	List Price	Sale Price
52-008-005-1	0 - 6"	Black	± 0.001"	\$122.49	\$109.00
52-008-007-1	0 - 6"	White	± 0.001"	\$122.49	\$109.00
52-008-008-1	0 - 8"	White	± 0.0015"	\$172.80	\$155.52
52-008-012-1	0 - 12"	White	± 0.002"	\$294.71	\$258.53

Prices & Specifications are subject to change without notice.



Inch & Metric Reading Dial Calipers

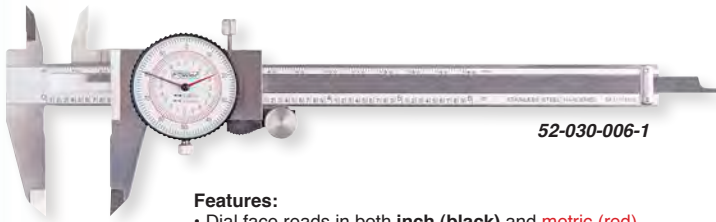

52-030-006-1

Features:

- Dial face reads in both **inch (black)** and **metric (red)**
- Hardened stainless steel throughout
- 4-way measuring
- Raised sliding surface prevents wear and defacement of graduations
- Covered stainless steel rack

Order No.	Range	Accuracy	List Price	Sale Price
52-030-006-1	6"/150mm	± 0.001"	\$132.21	\$116.34
52-030-012-1	12"/300mm	± 0.002"	\$218.06	\$191.89

XTRA-RANGE[®] Dial Calipers

With full length depth rod



52-008-018-0

Features:

- Graduations: 0.001"
- Jaw depth: 3.125"
- Stainless steel construction
- Satin chrome finish
- Full length depth rod
- 0.50" internal measuring nibs on jaws

Order No.	Range	Accuracy	List Price	Sale Price
52-008-018-0	0 - 18"	± 0.003"	\$324.88	\$286.24
52-008-024-0	0 - 24"	± 0.003"	\$393.69	\$345.05

XTRA-RANGE[®] Digital Calipers

For large measurements.

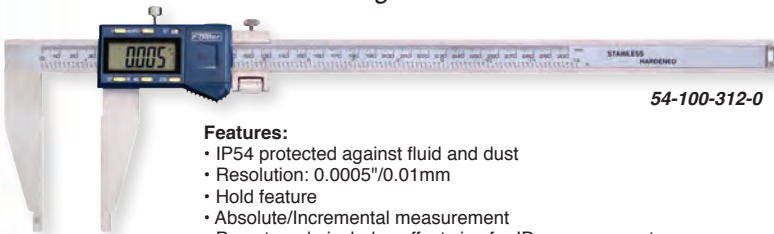

54-100-312-0

Features:

- IP54 protected against fluid and dust
- Resolution: 0.0005"/0.01mm
- Hold feature
- Absolute/Incremental measurement
- Preset mode includes offset size for ID measurements
- Both sizes feature fine adjustment

Order No.	Range	Accuracy	Jaw Depth	List Price	Sale Price
54-100-312-0	0 - 12"/300mm	± 0.002"/0.05mm	3.5"	\$280.71	\$252.35
54-100-024-1	0 - 24"/600mm	± 0.003"/0.075mm	4"	\$412.94	\$370.80
54-100-042-1	0 - 40"/1000mm	± 0.004"/0.010mm	4.9"	\$1,383.55	\$1,225.00

Rapid-Mic

Quick-Displacement Electronic Micrometers

Fastest micrometer on the market!



54-815-030-0

Features:

- IP67 protected against fluid and dust
- Non-rotating spindle with 0.39"/10mm travel per thimble rotation
- Adjustable measuring force, 5N/10N (54-815-030-0 and 54-815-130-0 only)
- Menu customizable with free software
- Larger sizes and specialty anvil micrometers also available



Calibration certificates available for all sizes.

Order No.	Range	Accuracy	List Price	Sale Price
54-815-030-0	0 - 1.18"/0 - 30mm	0.00012"/0.003mm	\$607.65	\$534.51
54-815-060-0	1.18" - 2.6"/30 - 66mm	0.00016"/0.004mm	\$1,112.13	\$1,012.04
54-815-100-0	2.6" - 4.0"/66 - 102mm	0.00020"/0.005mm	\$1,375.21	\$1,251.44
54-815-111-0	0 - 4"/0 - 102mm		\$3,167.95	\$2,745.60
Bluetooth Models				
54-815-130-0	0 - 1.18"/0 - 30mm	0.00012"/0.003mm	\$1,038.09	\$944.66
54-815-160-0	1.18" - 2.6"/30 - 66mm	0.00016"/0.004mm	\$1,363.84	\$1,241.09
54-815-110-0	2.6" - 4.0"/66 - 102mm	0.00020"/0.005mm	\$1,615.74	\$1,470.33
Bluetooth Set				
54-815-112-0	0 - 4"/0 - 102mm		\$3,960.49	\$3,604.04
Connectivity Cables/Accessories				
54-981-713-2	Sylcom Basic Data Processing Software		\$900.76	\$830.96
54-981-724-5	Sylcom Pro Data Processing Software		\$2,155.50	\$2,047.73
54-115-526-0	Proximity cable with USB connection		\$223.37	\$203.27
54-115-527-0	Proximity cable with serial connection		\$227.67	\$207.18
54-115-246-BT	USB Bluetooth receiver		\$54.94	\$47.17

DigiMic Electronic Micrometer

The **NEW** world standard of precision with IP67 and Bluetooth®.



Features:

- IP67 protected against fluid and dust
- Very High Accuracy: 0.00008"/0.002mm (0-1"/25mm)
- Bluetooth IOT ready, no dongle or cable required for SPC data collection
- Super large display (0.460"/11.75mm)
- Carbide measuring surfaces, sleep and absolute modes
- Larger sizes available



Calibration certificate available.

Order No. 54-816-025-0



Sale \$802.³⁷

List Price \$844.60

Prices & Specifications are subject to change without notice.

Electronic Coolant Resistant Micrometers

For basic outside measurements with higher protection.



Features:

- IP54 protected against fluid and dust
- Resolution: 0.0005"/0.001mm
- Carbide measuring faces
- Absolute & incremental modes
- Ratchet thimble
- Automatic switch off
- Free ball attachment included
- Sizes over 1"/25mm include a calibration standard

Order No.	Range	Accuracy	List Price	Sale Price
54-860-001-1	0 - 1"/0 - 25mm	± 0.00016"/0.004mm	\$151.09	\$120.87
54-860-002-1	1 - 2"/25 - 50mm w/standard	± 0.00016"/0.004mm	\$174.88	\$139.91
54-860-003-1	2 - 3"/50 - 75mm w/standard	± 0.0002"/0.005mm	\$190.70	\$152.56
54-860-004-1	3 - 4"/75 - 100mm w/standard	± 0.0002"/0.005mm	\$221.40	\$177.12
Set				
54-860-103-1	0 - 3"/0 - 75mm w/standard		\$496.80	\$397.44

XTRA-VALUE II Electronic Micrometers



Features:

- IP40 protected against fluid and dust
- Resolution: 0.00005"/0.001mm
- Carbide measuring faces
- Absolute and incremental modes
- Ratchet thimble
- Free ball attachment included
- Sizes over 1"/25mm include a calibration standard

Order No.	Range	Accuracy	List Price	Sale Price
54-870-001-0	0 - 1"/0 - 25mm	± 0.00016"/0.004mm	\$119.20	\$95.36
54-870-002-0	1" - 2"/25 - 50mm	± 0.00016"/0.004mm	\$128.72	\$102.98
54-870-003-0	2" - 3"/50 - 75mm	± 0.0002"/0.005mm	\$145.85	\$116.68
54-870-004-0	3" - 4"/75 - 100mm	± 0.0002"/0.005mm	\$163.10	\$130.48
Set				
54-870-103-0	0 - 3"/0 - 75mm		\$384.91	\$307.93

XTRA-MIC PLUS Electronic Micrometers

With EXTRA large display.



Features:

- IP54 protected against fluid and dust
- Corrosive resistant ratchet thimble (anodized aluminum)
- Super large LCD display, 14mm height
- Resolution: 0.00005"/0.001mm
- Carbide tipped anvil and spindle
- Sizes over 1"/25mm include a calibration standard
- Includes fitted case and two ball attachments

Order No.	Range	Accuracy	List Price	Sale Price
54-880-001-0	0 - 1"/0 - 25mm	0.00016"/0.004mm	\$169.17	\$110.00
54-880-002-0	1 - 2"/25 - 50mm	0.00016"/0.004mm	\$194.98	\$146.23
54-880-003-0	2 - 3"/50 - 75mm	0.0002"/0.005mm	\$208.43	\$156.32
54-880-004-0	3 - 4"/75 - 100mm	0.0002"/0.005mm	\$239.00	\$179.25
Set				
54-880-103-0	0 - 3"/0 - 75mm		\$538.08	\$403.56

0 - 1" BLUETOOTH Micrometer Kit

For wireless data acquisition.

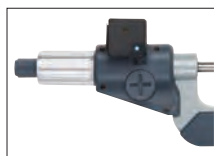

Features:

- IP54 protected against fluid and dust
- Transmitter simulates keyboard entries
- Rechargeable battery (transmitter) with automatic switch off
- Accuracy: $\pm 0.00016"/0.004mm$
- Resolution: 0.00005"/0.001mm
- Carbide measuring faces
- Absolute & incremental modes

Order No. 54-860-001-BT

Sale \$142.16

List \$189.54

Prices & Specifications are subject to change without notice.

Electronic IP65 Thread Micrometers

For accurate pitch diameter measurements.



54-219-001-0

Features:

- IP65 protected against fluid and dust
- Thread range: 64 - 3.5 TPI/0.4 - 7mm
- Accuracy: $\pm 0.00008''/0.002\text{mm}$
- 60° measuring anvils
- Absolute and incremental measuring mode
- Resolution: $0.00005''/0.001\text{mm}$
- Friction thimble

Order No.	Range	Thread Range	Accuracy	List Price	Sale Price
54-219-001-0	0 - 1''/0 - 25mm	64 - 5 TPI/0.4 - 5mm	$\pm 0.00008''/0.002\text{mm}$	\$322.15	\$293.16
54-219-002-0	1'' - 2''/25 - 50mm	44 - 3.5 TPI/0.6 - 7mm	$\pm 0.00008''/0.002\text{mm}$	\$338.89	\$303.85
54-219-003-0	2'' - 3''/50 - 75mm	24 - 3.5 TPI/1 - 7mm	$\pm 0.00008''/0.002\text{mm}$	\$344.13	\$313.12
54-219-004-0	3'' - 4''/75 - 100mm	24 - 3.5 TPI/1 - 7mm	$\pm 0.00012''/0.003\text{mm}$	\$358.86	\$326.51

Vernier Thread Micrometers



52-219-001-1

Features:

- 60° measuring anvils
- Graduation: 0.001"
- Ratchet thimble
- Sizes over 1" include standard

Order No.	Range	Thread Range	Accuracy	List Price	Sale Price
52-219-001-1	0 - 1"	64 - 5 TPI/0.4 - 5mm	0.00016"	\$128.67	\$117.09
52-219-002-1	1" - 2"	44 - 3.5 TPI/0.6 - 7mm	0.00016"	\$141.65	\$128.90
52-219-003-1	2" - 3"	24 - 3.5 TPI/1 - 7mm	0.0002"	\$165.18	\$150.31
52-219-004-1	3" - 4"	24 - 3.5 TPI/1 - 7mm	0.0002"	\$178.87	\$162.77

Vernier Inch Blade Micrometers

Use blade micrometers to measure the outside diameter of workpieces which have narrow grooves, "T" slots and other features.



52-246-001-1

Features:

- Anvil & spindle hardened & precision ground with microlap finish on ends
- Non-rotating spindle
- Ratchet thimble
- Graduation: 0.0001"
- Blade thickness = 0.030"; blade width = 0.256"; blade penetration = 0.315"
- Sizes over 1" include a standard

Order No.	Range	Accuracy	List Price	Sale Price
52-246-001-1	0 - 1"	0.00016"	\$270.93	\$216.74
52-246-002-1	1" - 2"	0.00016"	\$294.96	\$235.97
52-246-003-1	2" - 3"	0.0002"	\$307.96	\$246.37
52-246-004-1	3" - 4"	0.0002"	\$313.85	\$251.08
52-246-005-1	4" - 5"	0.00024"	\$334.75	\$267.80
52-246-006-1	5" - 6"	0.00024"	\$355.35	\$284.28
52-246-007-1	6" - 7"	0.00028"	\$375.95	\$300.76

Interchangeable Anvil Micrometers

Very popular in machine and auto repair and for all other applications requiring a versatile micrometer. Each micrometer is equipped with a series of easily interchangeable anvils to fulfill the ranges listed.

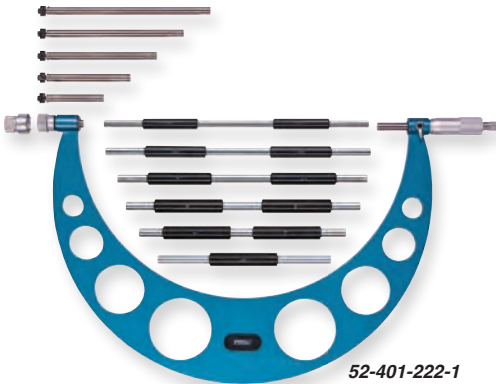

52-401-222-1

Features:

- Ratchet thimble
- Microfine graduations on satin chrome finish for easy reading
- Each anvil fitted with an adjusting collar to set the overall dimension
- Carbide tipped measuring faces
- Positive lever locking clamp

Order No.	Range	Graduation	Accuracy	List Price	Sale Price
52-401-221-1	0 - 6"	0.0001"	0.00016"	\$322.19	\$257.75
52-401-222-1	6" - 12"	0.0001"	0.00016"	\$473.17	\$378.54
52-401-204-1	12" - 16"	0.001"	0.0002"	\$567.84	\$454.27
52-401-205-1	16" - 20"	0.001"	0.0002"	\$662.39	\$529.91

Outside Vernier Micrometers

0.001" readings.



52-253-001-1

Features:

- Graduation: 0.001"
- Carbide tipped measuring faces
- Diameter of measuring faces: 0.256"
- Anvil & spindle hardened and precision ground with microlap finish on tips
- Sizes over 1"/25mm include a standard

Order No.	Range	Accuracy	Thimble	List Price	Sale Price
52-253-001-1	0 - 1"	± 0.001"	Friction	\$42.95	\$39.09
52-253-101-1	0 - 1"	± 0.001"	Ratchet	\$42.95	\$39.09
52-253-002-1	1" - 2"	± 0.001"	Friction	\$51.04	\$46.44
52-253-102-1	1" - 2"	± 0.001"	Ratchet	\$51.04	\$46.44
52-253-003-1	2" - 3"	± 0.001"	Ratchet	\$59.36	\$49.44
52-253-004-1	3" - 4"	± 0.001"	Ratchet	\$69.36	\$56.65
52-253-005-1	4" - 5"	± 0.001"	Ratchet	\$77.45	\$64.89
52-253-006-1	5" - 6"	± 0.001"	Ratchet	\$85.78	\$72.10

Outside Vernier Micrometer Set

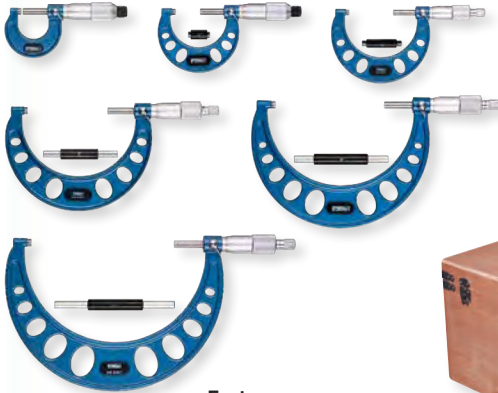

Features:

- Range: 0 - 6"
- Carbide tipped measuring faces
- Graduation: 0.001"
- Diameter of measuring faces: 0.256"
- Anvil & spindle hardened and precision ground with microlap finish on tips
- Sizes over 1"/25mm include a standard

Order No. 52-253-600-1

Sale \$319.³⁰

List Price \$393.78

Outside Vernier Micrometers

0.0001" graduations for higher accuracy.



52-240-001-1



52-215-003-1

Features:

- Graduation: 0.0001"
- Microfine graduations on satin chrome finish and carbide tipped measuring faces
- Diameter of measuring faces: 0.256"
- Flatness: 0.00003"
- Spindle thread hardened, ground and lapped for ultimate accuracy
- Includes a wrench and case
- Sizes over 1"/25mm include a standard

Order No.	Range	Accuracy	Thimble	List Price	Sale Price
52-240-001-1	0 - 1"	± 0.00016"	Friction	\$51.04	\$43.74
52-240-101-1	0 - 1"	± 0.00016"	Ratchet	\$51.04	\$43.74
52-240-002-1	1" - 2"	± 0.00016"	Friction	\$59.36	\$50.88
52-240-102-1	1" - 2"	± 0.00016"	Ratchet	\$59.36	\$50.88
52-240-003-1	2" - 3"	± 0.0002"	Ratchet	\$69.36	\$59.45
52-240-004-1	3" - 4"	± 0.0002"	Ratchet	\$77.45	\$66.38
52-240-005-1	4" - 5"	± 0.00024"	Ratchet	\$85.78	\$73.52
52-240-006-1	5" - 6"	± 0.00024"	Ratchet	\$93.99	\$80.56
52-240-007-1	6" - 7"	± 0.00028"	Ratchet	\$102.19	\$87.59
52-240-008-1	7" - 8"	± 0.00028"	Ratchet	\$120.27	\$103.09
52-240-009-1	8" - 9"	± 0.00032"	Ratchet	\$136.69	\$117.16
52-240-010-1	9" - 10"	± 0.00032"	Ratchet	\$155.02	\$132.87
52-240-011-1	10" - 11"	± 0.00036"	Ratchet	\$171.43	\$146.94
52-240-012-1	11" - 12"	± 0.00036"	Ratchet	\$187.84	\$161.01
Sets					
52-215-003-1	0 - 3" with standards and fitted shop hardened case			\$177.85	\$152.45
52-215-004-1	0 - 4" with standards and fitted shop hardened case			\$254.82	\$216.30
52-215-006-1	0 - 6" with standards and fitted shop hardened case			\$432.56	\$360.50
52-215-012-1	0 - 12" with standards and fitted wooden case			\$1,311.35	\$1,124.02
52-215-612-1	6 - 12" with standards and fitted wooden case			\$865.12	\$741.53

Digit Counter Micrometers

0.001" digit counter.



52-224-001-1

Features:

- Digital counter reads to 0.001"
- Graduations: 0.0001" (using vernier)
- Microfine graduations on satin chrome
- Carbide tipped measuring faces
- Sizes over 1¹/₂mm include a standard
- Includes case

Order No.	Range	Accuracy	List Price	Sale Price
52-224-001-1	0 - 1"	0.00016"	\$139.43	\$108.67
52-224-002-1	1" - 2"	0.00016"	\$146.45	\$101.46
52-224-003-1	2" - 3"	0.0002"	\$166.79	\$115.57
52-224-004-1	3" - 4"	0.0002"	\$183.57	\$127.21
52-224-005-1	4" - 5"	0.00024"	\$194.27	\$176.78
52-224-006-1	5" - 6"	0.00024"	\$203.07	\$184.80
Sets				
52-224-103-0	0 - 3" set (set finished in grey enamel)		\$440.05	\$304.88
52-224-104-0	0 - 4" set (set finished in grey enamel)		\$624.09	\$432.29
52-224-220-0	0 - 75mm set (set finished in grey enamel)		\$463.37	\$320.95

Micrometer Stands



52-247-005-0

Features:

- Unique locking system adjusts micrometer stand to any position for perfect use and viewing
- Stand folds for storage

XTRA MAG

Features:

- Holds standard 0-12" micrometers firmly to metal surfaces
- Use at machine centers, assembly and inspection stations, steel tables and shelves
- V-bottom for mounting on cylindrical surfaces
- On/Off magnet switch
- Base is 2.30" L x 1.20" W x 3.50" H



52-247-010-0

Micrometer not included

Order No.	Description	List Price	Sale Price
52-247-005-0	Folding Micrometer Stand	\$48.66	\$44.28
52-247-010-0	Magnetic Micrometer Stand	\$86.08	\$78.33

IP54 Electronic Depth Micrometer



Features:

- IP54 protected against fluid and dust
- Range: 0 - 6"/150 mm
- Resolution: 0.00005"/0.001mm
- Base surface hardened and microlapped to 0.00008" flatness
- Rod diameter: 0.176"
- Includes fitted case

Order No. 54-225-456-0

Sale \$253.³²

List Price \$278.38

Vernier Depth Micrometers



52-225-110-0



52-225-116-0

Features:

- Base surface hardened and microlapped to 0.00008"
- Ratchet thimble
- Locking clamp
- Rod diameter: 0.176"
- Includes fitted case

Order No.	Range	Graduation	Accuracy	Base Size	List Price	Sale Price
52-225-110-0	0 - 4"	0.001"	0.0002"	2.5"	\$165.72	\$150.80
52-225-112-0	0 - 6"	0.001"	0.0002"	2.5"	\$195.70	\$178.09
52-225-114-0	0 - 4"	0.001"	0.0002"	4"	\$179.04	\$162.93
52-225-116-0	0 - 6"	0.001"	0.0002"	4"	\$209.50	\$190.65
52-225-035-1	0 - 12"	0.001"	0.00028"	4"	\$421.73	\$383.78

Prices & Specifications are subject to change without notice.

Bowers Bore Gaging



XTH3 Bluetooth Holematic Pistol Grips

Have a long run of a single part? The XTH3 is the fastest, most consistent hole measurement system available world wide!



Pistol grip design significantly decreases measuring time and guarantees repeatability.

Systems



XTD3 Bluetooth Electronic Holemikes

Designed to measure hard to reach bores. Measure cylinder bores, high accuracy bearings, grooves, threads and much more!



Traditional style ratchet stop thimble

Special application heads

Contact the Fowler Technical Department 1-800-788-2353

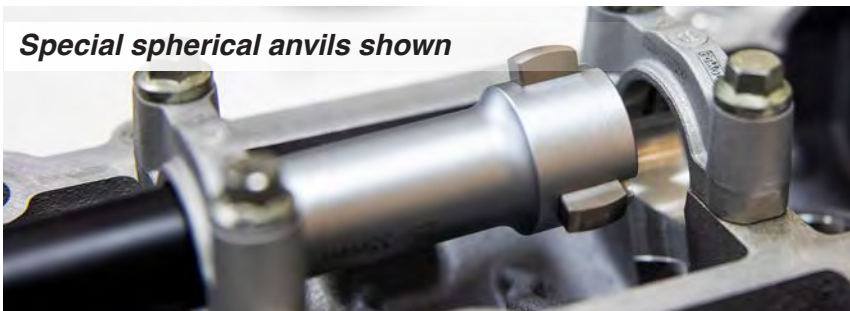
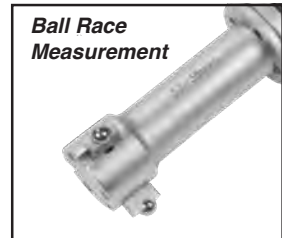

Order No.	Range	Includes	List Price	Sale Price
Pistol Grip Individual Sets				
54-567-720-BT	0.750" - 1"/20 - 25mm	1 head, 1 handle, 1 ring	\$2,774.23	\$2,524.55
54-567-725-BT	1" - 1.375"/25 - 35mm	1 head, 1 handle, 1 ring	\$2,995.57	\$2,725.97
54-567-735-BT	1.375" - 2"/35 - 50mm	1 head, 1 handle, 1 ring	\$3,075.38	\$2,798.60
Pistol Grip Complete Sets				
54-567-009-BT	0.080" - 0.250"/2 - 6mm (2 pt.)	5 heads, 1 handle, 3 rings	\$7,033.38	\$6,400.37
54-567-010-BT	0.250" - 0.375"/6 - 10mm	2 heads, 1 handle, 1 ring	\$2,757.87	\$2,509.66
54-567-020-BT	0.375" - 0.750"/10 - 20mm	3 heads, 1 handle, 2 rings	\$3,226.40	\$2,936.03
54-567-050-BT	0.750" - 2"/20 - 50mm	3 heads, 1 handle, 2 rings	\$4,165.94	\$3,791.00
54-567-100-BT	2" - 4"/50 - 100mm	3 heads, 1 handle, 2 rings	\$4,636.93	\$4,219.60
54-567-105-BT	4" - 6"/100 - 150mm	2 heads, 1 handle, 1 ring	\$4,165.94	\$3,791.00
54-567-110-BT	6" - 8"/150 - 200mm	2 heads, 1 handle, 1 ring	\$5,498.92	\$5,004.02
54-567-200-BT	4" - 8"/100 - 200mm	4 heads, 1 handle, 2 rings	\$8,703.75	\$7,920.41
54-567-210-BT	0.750" - 4"/20 - 100mm	6 heads, 1 handle, 4 rings	\$6,779.41	\$6,169.26
54-567-620-BT	0.250" - 0.750"/6 - 20mm	5 heads, 1 handle, 3 rings	\$3,845.24	\$3,499.17
Connectivity Cables/Accessory				
54-115-526-0	Proximity cable with USB connection		\$223.37	\$203.27
54-115-527-0	Proximity cable with serial connection		\$227.67	\$207.18
54-115-246-BT	USB bluetooth receiver		\$54.94	\$47.17

operate with either style handle



Bowers Bore Gaging Sets

The best solution for measuring multiple size bores.

2" - 4" Set



54-567-100-BT

3/8" - 3/4" Set



54-367-020-BT



Both styles feature:

- Coolant proof, dust proof - IP67
- Resolution: 0.00005"/0.001mm
- Bluetooth connectivity to your phone or tablet
- Self centering 3 point heads above 0.250"
- Tungsten carbide measuring faces on all 3-point heads from 0.5"/12.5mm and up
- Sizes over 0.500"/12.5mm feature blind bore capability
- Includes UKAS certificates for all pistol grip, heads and rings

Order No.	Range	Includes	List Price	Sale Price
Holmike Complete Sets (Traditional style)				
54-367-000-BT	0.080" - 0.250"/2 - 6mm (2 pt.)	5 heads, 1 handle, 3 rings	\$6,409.88	\$5,832.99
54-367-010-BT	0.250" - 0.375"/6- 10mm	2 heads, 1 handle, 1 ring	\$2,670.76	\$2,430.39
54-367-020-BT	0.375" - 0.750"/10 - 20mm	3 heads, 1 handle, 2 rings	\$3,187.03	\$2,900.19
54-367-050-BT	0.750" - 2"/20 - 50mm	3 heads, 1 handle, 2 rings	\$4,328.12	\$3,938.59
54-367-100-BT	2" - 4"/50 - 100mm	3 heads, 1 handle, 2 rings	\$4,791.89	\$4,360.62
54-367-105-BT	4" - 6"/100 - 150mm	2 heads, 1 handle, 1 ring	\$4,045.47	\$3,681.38
54-367-110-BT	6" - 8"/150 - 200mm	2 heads, 1 handle, 1 ring	\$5,343.86	\$4,862.91
54-367-200-BT	4" - 8"/100 - 200mm	4 heads, 1 handle, 2 rings	\$8,443.90	\$7,683.95
Connectivity Cables/Accessory				
54-115-526-0	Proximity cable with USB connection		\$223.37	\$203.27
54-115-527-0	Proximity cable with serial connection		\$227.67	\$207.18
54-115-246-BT	USB bluetooth receiver		\$54.94	\$47.17



XT Hometric Groove Sets

General sizes available.



Features:

- Coolant proof, dust proof - IP67
- Pistol grip handle for FAST measurements
- Resolution: 0.00005"/0.001mm, direct in/mm conversion
- Error free bluetooth data transfer
- Includes depth stops and UKAS certified setting rings
- Special sizes, profiles and depth extensions available to measure any bore feature

Order No.	Sizes Included	Anvil Step Height	Anvil Contact Width	List Price	Sale Price
54-344-001-0	1/4" - 5/16"	0.049"	0.059"	\$6,867.53	\$6,249.45
	5/16" - 3/8"	0.049"	0.059"		
	3/8" - 1/2"	0.059"	0.059"		
	1/2" - 5/8"	0.079"	0.059"		
	5/8" - 3/4"	0.098"	0.059"		
54-344-002-0	3/4" - 1"	0.108"	0.079"	\$5,677.88	\$5,166.87
	1" - 1-3/8"	0.217"	0.079"		
	1-3/8" - 2"	0.157"	0.079"		
54-344-003-0	2" - 2-5/8"	0.315"	0.118"	\$6,326.78	\$5,757.37
	2-5/8" - 3-1/4"	0.315"	0.118"		
	3-1/4" - 4"	0.413"	0.118"		

MicroGage

Pocket sized 2-point bore gaging system.



Replaces 100's of pin gages!



Features:

- System range : 0.040" - 0.250"/1 - 6mm
- Switchable resolution 0.0005", 0.00005"/0.01, 0.001, 0.0005mm
- Repeatability : 0.00005"/0.001mm
- Sets include setting rings with UKAS certificates
- Depth stops available, call our technical department 1-800-788-2353

Order No.	Description	List Price	Sale Price
54-551-010-0	0.037" - 0.096"/0.95 - 2.45mm	\$3,762.79	\$3,499.39
54-551-011-0	0.060" - 0.167"/1.5 - 4.25mm	\$3,682.62	\$3,351.18
54-551-012-0	0.089" - 0.250"/2.25 - 6.35mm	\$3,964.23	\$3,607.45
Connectivity Cables			
54-115-526-0	Proximity cable with USB connection	\$223.37	\$203.27
54-115-527-0	Proximity cable with serial connection	\$227.67	\$207.18

Bowers Ultima Bore Gaging System

World's most accurate system!



D62S

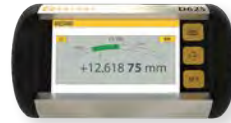

Display not included

Features:

- Accuracies of 0.00004" up to 1.97"
- Ceramic anvils with blind bore capabilities above 0.472"
- Uses compact, multi function Sylvac display

Order No.	Description	Set Includes	List Price	Sale Price
54-565-006-1	0.078" - 0.236"/2 - 6mm	Includes: handle, rings & heads	\$7,642.60	\$6,954.77
54-565-010-1	0.236" - 0.393"/6 - 10mm	Includes: handle, rings & heads	\$4,150.90	\$3,777.32
54-565-020-1	0.393" - 0.787"/10 - 20mm	Includes: handle, rings & heads	\$6,175.54	\$5,619.74
54-565-070-1	0.236" - 0.787"/6 - 20mm	Includes: handle, rings & heads	\$9,658.72	\$8,789.44
54-565-080-1	0.787" - 1.97"/20 - 50mm	Includes: handle, rings & heads	\$10,589.24	\$9,636.21
54-565-090-1	1.97" - 3.94"/50 - 100mm	Includes: handle, rings & heads	\$11,758.98	\$10,700.68
54-565-100-1	0.787" - 3.94"/20 - 100mm	Includes: handle, rings & heads	\$18,007.01	\$16,386.38
Digital Displays				
54-618-106-2	Sylvac D62S Digital Display		\$1,490.61	\$1,370.00
54-618-106-3	Sylvac D62S Advanced Digital Display		\$2,202.40	\$2,035.00

XT-Series Holemikes

Vernier Bore Micrometers.



52-255-316-0

Features:

- 3-pt contact with tungsten carbide measuring anvils above 0.5"
- Blind bore measuring heads featured above 0.5"
- Ratchet stop for consistent measuring
- Extensions available for deep measuring
- Includes UKAS certificates for all Holemikes and setting rings



Order No.	Range	Grads.	Meas. Accuracy	Ring Depth	Ring Included	List Price	Sale Price
52-255-310-0	0.250" - 0.312"	0.00025"	0.00015"	2.28"	0.312"	\$829.07	\$614.13
52-255-311-0	0.312" - 0.375"	0.00025"	0.00015"	2.28"	0.312"	\$767.67	\$568.64
52-255-312-0	0.375" - 0.500"	0.00025"	0.00015"	2.28"	0.5"	\$767.67	\$568.64
52-255-313-0	0.500" - 0.625"	0.00025"	0.00015"	2.44"	0.5"	\$767.67	\$568.64
52-255-314-0	0.625" - 0.750"	0.00025"	0.00015"	2.44"	0.75"	\$787.25	\$583.14
52-255-315-0	0.750" - 1"	0.00025"	0.00015"	2.60"	0.75"	\$864.56	\$640.41
52-255-316-0	1" - 1.375"	0.00025"	0.00015"	2.60"	1.375"	\$1,231.87	\$912.50
52-255-317-0	1.375" - 2"	0.00025"	0.00015"	3.15"	1.375"	\$1,261.24	\$934.25
52-255-318-0	2" - 2.625"	0.00025"	0.0002"	3.15"	2.625"	\$1,504.52	\$1,114.46
52-255-319-0	2.625" - 3.250"	0.00025"	0.0002"	3.15"	2.625"	\$1,517.98	\$1,124.43
52-255-320-0	3.250" - 4"	0.00025"	0.0002"	3.94"	3.25"	\$1,893.75	\$1,402.78
Sets							
52-255-565-0	0.250" - 0.375"	2 heads, 2 handles, 1 ring				\$1,840.91	\$1,363.64
52-255-665-0	0.375" - 0.750"	3 heads, 3 handles, 2 rings				\$2,096.32	\$1,552.83
52-255-775-0	0.750" - 2"	3 heads, 3 handles, 2 rings				\$3,293.82	\$2,439.86
52-255-885-0	2" - 4"	3 heads, 3 handles, 2 rings				\$4,465.29	\$3,307.62

Prices & Specifications are subject to change without notice.

Dial Cylinder Bore Gages

2-point bore measuring.

Features:

- Carbide Anvils
- Easy-to-read
- Great value
- Graduation: 0.0005", 0.0001" or 0.01mm
- Insulated grip
- 9.5" depth above 1.5"
- Chrome plated handle

XTENDER



52-646-400-0



Order No.	Range	Graduation	List Price	Sale Price
52-646-100-0	0.7" - 1.5"	0.0005"	\$188.20	\$146.67
52-646-300-0	2" - 6"	0.0005"	\$155.60	\$136.94
52-646-400-0	1.4" - 6"	0.0005"	\$236.50	\$184.37
52-646-500-0	1.4" - 6"	0.0001"	\$307.04	\$270.58
52-646-220-0	35 - 60mm	0.01mm	\$269.32	\$237.31
Extensions				
52-646-450-0	20" depth extension <i>*Not for use with 52-646-100-0</i>		\$105.24	\$95.76
52-646-475-0	40" depth extension <i>*Not for use with 52-646-100-0</i>		\$135.35	\$123.17

Internal & External Electronic Caliper Gages

For grooves and recesses.



54-554-611-0



54-554-711-0

Features:

- Accuracy: $\pm 0.0008'' \pm 0.02\text{mm}$
- Resolution: $0.0002''/0.005\text{mm}$
- Analog scale for reversal point indication
- Large, LCD display
- Preset capability
- Absolute and incremental measurements modes
- High-impact, aircraft aluminum case
- Rugged housing

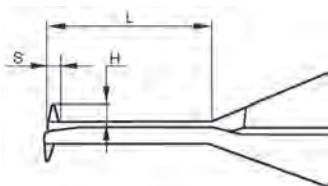

Dimensions for Internal Calipers

Metric	Inch	L	S	H	Tip Radius
5-15mm	0.2-0.6"	20mm	1.0mm	1.5mm	0.3mm
5-25mm	0.2-1.0"	35mm	1mm	1.5mm	0.3mm
10-30mm	0.4-1.2"	55mm	2mm	3.5mm	0.5mm
20-40mm	0.8-1.6"	80mm	3mm	6.5mm	0.5mm
30-50mm	1.2-2.0"	80mm	3mm	8.5mm	0.5mm

Dimensions for External Calipers

Metric	Inch	L	S	H	Tip Radius
0-10mm	0-0.4"	40mm	3mm	8mm	0.5mm
0-20mm	0-0.8"	80mm	6.5mm	25mm	0.75mm
10-30mm	0.4-1.2"	80mm	6.5mm	25mm	0.75mm
20-40mm	0.8-1.6"	80mm	6.5mm	25mm	0.75mm
30-50mm	1.2-2.0"	80mm	6.5mm	25mm	0.75mm

Order No.	Range	List Price	Sale Price
Internal Caliper Gages			
54-554-611-0	0.200" - 0.590"/5 - 15mm	\$230.56	\$206.00
54-554-622-0	0.200" - 1"/5 - 25mm	\$247.21	\$221.45
54-554-623-0	0.400" - 1.2"/10 - 30mm	\$258.75	\$235.46
54-554-624-0	0.790" - 1.6"/20 - 40mm	\$258.75	\$235.46
54-554-625-0	1.2" - 2"/30 - 50mm	\$258.75	\$235.46
External Caliper Gages			
54-554-711-0	0 - 0.400"/0 - 10mm	\$230.56	\$206.00
54-554-722-0	0 - 0.790"/0 - 20mm	\$247.21	\$221.45
54-554-723-0	0.4" - 1.2"/10 - 30mm	\$258.75	\$235.46
54-554-724-0	0.790" - 1.6"/20 - 40mm	\$258.75	\$235.46
54-554-725-0	1.2" - 2"/30 - 50mm	\$258.75	\$235.46

Mark VI Electronic Indicators

Our BEST digital indicators!

Features:

- IP54 protected against fluid and dust
- Repeatability: 0.00008"/0.002mm
- Output: Proximity/Power - USB/RS232/digimatic/Wireless
- Menus customizable with free software
- Functions (MIN/MAX/DELTA, TOL, Factor, Preset, Auto Off)
- Bezel rotates 270°
- Large display with LED tolerance indicators
- Includes lug back



54-530-335-0

Calibration certificates available for all sizes.

Order No.	Range	Accuracy	Resolution	List Price	Sale Price
Low Resolution					
54-530-125-0	0 - 0.500"/12.5mm	0.0004"/0.01mm	0.0005"/0.01mm	\$559.53	\$509.17
54-530-145-0	0 - 1"/25mm	0.0004"/0.01mm	0.0005"/0.01mm	\$638.65	\$581.17
High Resolution					
54-530-135-0	0 - 0.500"/12.5mm	0.00012"/0.003mm	0.00005"/0.001mm	\$692.33	\$630.02
54-530-155-0	0 - 1"/25mm	0.00016"/0.004mm	0.00005"/0.001mm	\$757.34	\$689.18
54-530-175-0	0 - 2"/50mm	0.00019"/0.005mm	0.00005"/0.001mm	\$1,328.17	\$1,208.64
Bluetooth					
54-530-335-0	0 - 0.500"/12.5mm	0.00012"/0.003mm	0.00005"/0.001mm	\$876.03	\$797.19
54-530-355-0	0 - 1"/25mm	0.00016"/0.004mm	0.00005"/0.001mm	\$935.37	\$851.18
Accessories					
54-981-713-2	Sylcom Basic Data Processing Software			\$900.76	\$830.96
54-981-724-5	Sylcom Pro Digital License			\$2,155.50	\$2,047.73
54-115-246-BT	USB Bluetooth Receiver			\$54.94	\$47.17

Mini S_Dial Indicators

Small in size BIG in features!

Features:

- Bluetooth connectivity to your phone or tablet
- IP67 protected against fluid and dust
- All indicators feature 0.50"/12.5mm range
- Analog scale for reversal point indication, Min/Max, multiplication factor (Bluetooth® models only)
- 3/8" mounting diameter with 4-48 contact thread
- Auto power off feature
- Optional cable connectivity output



54-520-687-BT

54-520-692-0



Calibration certificates available for all sizes.

Order No.	Accuracy	Resolution	List Price	Sale Price
Bluetooth Models				
54-520-687-BT	0.0004"/0.01mm	0.0005"/0.01mm	\$658.42	\$599.17
54-520-690-BT	0.0002"/0.005mm	0.00005"/0.001mm	\$835.21	\$760.04
Basic Models (Zero set, preset, in/mm, measuring direction)				
54-520-691-0*	0.0004"/0.01mm	0.0005"/0.01mm	\$483.55	\$440.03
54-520-692-0*	0.0002"/0.005mm	0.00005"/0.001mm	\$667.61	\$607.52
Accessories				
54-981-713-2	Sylcom Basic Data Processing Software		\$900.76	\$830.96
54-115-528-0	USB Power Cable		\$359.26	\$326.93

*Basic models feature only simple functions.



Electronic Test Indicators

Features:

- Bluetooth connectivity to your phone or tablet
- IP65 protected against fluid and dust
- 4 measuring modes: Min, Max, TIR and Direct
- 4 measuring resolutions - 0.00005"/0.001mm or 0.0005"/0.01mm
- 1-1/2" diameter dial face rotates a full 360°
- Analog scale for reversal point indication
- Meets or exceeds DIN/ISO Standards (Maximum error on 0.00005" scale at full range: 0.0004")
- 54-562-890-BT is capable of interchanging contact point lengths



54-562-777-BT

Calibration certificates available for all sizes.

Order No.	Range	Contact Point Length	List Price	Sale Price
54-562-777-BT	0.030"/0.80mm	1/2"	\$647.12	\$595.35
54-562-888-BT	0.080"/2.0mm	1-7/16"	\$731.90	\$673.35
54-562-890-BT	0.030"/0.80mm	1/2"	\$796.91	\$733.16
	0.080"/2.0mm	1-7/16"		
Accessories				
54-981-713-2	Sylcom Basic Data Processing Software		\$900.76	\$830.96
54-115-528-0	USB Power Cable		\$359.26	\$326.93

NEW S_Depth Gages

Perfect for measuring depths, groove widths, slot widths, recess heights, step heights and through holes.

Features:

- IP67 protected against fluid and dust
- Bluetooth connectivity to your phone or tablet
- 3 measuring styles available
- 4"/100mm measuring base as standard
- Optional bases available for larger widths
- Optional probes available for 54-139-160 series
- Extra large display
- Absolute measuring system



Rotary Pin Series
54-139-162-3



54-139-161-1



54-139-160-5

Order No.	Description	List Price	Sale Price
54-139-160-1	8"/200mm Interchangeable Anvil Bluetooth Depth Gage	\$1,310.00	\$1,179.00
54-139-160-3	12"/300mm Interchangeable Anvil Bluetooth Depth Gage	\$1,510.00	\$1,359.00
54-139-160-5	19"/500mm Interchangeable Anvil Bluetooth Depth Gage	\$2,020.00	\$1,818.00
54-139-161-1	8"/200mm Standard Style Bluetooth Depth Gage	\$1,240.00	\$1,116.00
54-139-161-3	12"/300mm Standard Style Bluetooth Depth Gage	\$1,410.00	\$1,269.00
54-139-161-5	19"/500mm Standard Style Bluetooth Depth Gage	\$1,780.00	\$1,602.00
54-139-162-1	8"/200mm Rotary Pin Bluetooth Depth Gage	\$1,340.00	\$1,206.00
54-139-162-3	12"/300mm Rotary Pin Bluetooth Depth Gage	\$1,510.00	\$1,359.00
54-139-162-5	19"/500mm Rotary Pin Bluetooth Depth Gage	\$2,050.00	\$1,845.00

Our most popular electronic indicators.



54-520-255-0



54-520-250-0



54-520-260-0

Features:

- Accuracy: $\pm 0.001"/0.03\text{mm}$
- Resolution $0.0005"/0.01\text{mm}$
- 54-520-260-0 also reads 1/64ths
- 2-1/4" dial face
- Lugback and 3/8" stem mountings
- Tolerance function
- Absolute/incremental reading
- Floating zero

Calibration certificates available for all sizes.

Order No.	Range	List Price	Sale Price
54-520-255-0	0.50"/12.5mm	\$123.96	\$94.45
54-520-250-0	1"/25mm	\$133.36	\$108.15
54-520-260-0	1"/25mm	\$135.38	\$111.01

INDI-X^{BT} Electronic Indicators

Smart Wireless Communication to most phones and tablets.



54-520-285-0



54-520-280-0

Features:

- Bluetooth compatible to most phones and tablets
- Resolution $0.00005"/0.001\text{mm}$
- Economical bluetooth option
- Includes lifting hook, ceramic ball contact point, 2 specialty contact points (spline and point), NIST cert., lug and flat backs

Calibration certificates available for all sizes.

Order No.	Range	Accuracy	List Price	Sale Price
54-520-280-0	0 - 1"/25mm	0.00035"/0.008mm	\$185.80	\$157.93
54-520-285-0	0 - 0.50"/12.5mm	0.00030"/0.007mm	\$179.67	\$152.72

X-TEST®**Horizontal & Vertical Test Indicators****Features:**

- Super smooth jeweled movement
- Smooth bezel adjustment for easy zero setting
- Solid brass anti-magnetic housing
- 0.080" and 0.120" carbide ball contact points (0.040" steel ball)
- 0.060" range with auto reverse and rev. counter
- Easy to read tilted dial
- 5/32" pivotable stem



52-562-005-0



52-562-001-0



52-562-002-BD

Order No.	Graduation	Dial Size	Dial Reading	List Price	<i>Sale Price</i>
Horizontal					
52-562-001-0	0.0005"	1-1/2"	0 - 15 - 0	\$159.05	\$144.74
52-562-001-BD	0.0005"	1-1/2"	0 - 15 - 0	\$159.05	\$144.74
52-562-002-0	0.0005"	1"	0 - 15 - 0	\$159.05	\$144.74
52-562-002-BD	0.0005"	1-1/2"	0 - 15 - 0	\$159.05	\$144.74
52-562-003-0	0.001"	1"	0 - 15 - 0	\$159.05	\$144.74
52-562-008-0	0.01mm	38mm	0 - 40 - 0	\$159.05	\$144.74
Vertical					
52-562-004-0	0.0005"	1-1/2"	0 - 15 - 0	\$174.16	\$135.75
52-562-005-0	0.0005"	1"	0 - 15 - 0	\$174.16	\$135.75

Test Indicators

All Fowler Test Indicators include bi-directional constant clockwise rotation, automatic reversal, three dovetail mountings, jeweled movement, two dovetail clamps and a molded case.

**0.001"
0.0005"
Reading**



52-562-776-0



52-562-778-0



Order No.	Dial Color	Total Range	Dial Reading	Graduation	Dial Diameter	Point Length	List Price	<i>Sale Price</i>
52-562-774-0	white	0.030"	0-15-0	0.001"	1"	1/2"	\$149.54	\$136.08
52-562-778-0	black	0.030"	0-15-0	0.0005"	1"	1/2"	\$158.94	\$144.63
52-562-775-0	white	0.030"	0-15-0	0.0005"	1"	1/2"	\$158.94	\$144.63
52-562-776-0	white	0.030"	0-15-0	0.0005"	1-1/2"	1/2"	\$166.19	\$151.23
52-562-780-0	black	0.030"	0-15-0	0.0005"	1-1/2"	1/2"	\$166.19	\$151.23

Premium Dial Indicators

Features:

- AGD Group 2 specifications
- Shockproof gearing
- Jeweled movement
- Tolerance markers
- Solid steel housing
- Carbide contact point
- Includes NIST Certification



52-520-135-0



52-520-105-0



52-520-110-1

Order No.	Range	Graduation	Reading	Balanced Reading	Dial Color	List Price	Sale Price
52-520-135-0	0.05"	0.0001"	0 - 10	0 - 5 - 0	White	\$199.55	\$151.41
52-520-105-0	0.50"	0.001"	0 - 100	0 - 50 - 0	White	\$105.64	\$80.48
52-520-110-1	1"	0.001"	0 - 100	—	Black	\$111.70	\$89.35
52-520-110-2	1"	0.001"	0 - 100	—	White	\$111.70	\$89.35
52-520-120-0	2"	0.001"	0 - 100	—	White	\$178.08	\$144.20
52-520-125-0	0.250"	0.0005"	0 - 100	—	White	\$147.39	\$112.30
52-520-129-0	1"	0.0005"	0 - 50	0 - 25 - 0	White	\$135.02	\$102.88
52-520-300-0	10mm	0.01mm	0 - 100	0 - 50 - 0	White	\$127.53	\$97.17
52-520-500-0	25mm	0.01mm	0 - 100	0 - 50 - 0	White	\$170.00	\$123.60

Premium IP54 Shockproof Dial Indicators

Features:

- IP54 protected against fluid and dust
- Includes both center lug back and flat back
- Steel housing
- Sealed plunger, dust-cap and back plate
- Carbide contact point
- 0 - 100 dial reading with revolution counter
- Includes NIST Certification



52-520-460-0



52-520-465-0

Order No.	Range	Graduation	Reading	Contact Point	List Price	Sale Price
52-520-460-0	1"	0.001"	0 - 100	4 - 48 (3/8" stem)	\$121.22	\$97.85
52-520-465-0	1"	0.001"	0 - 100	4 - 48 (3/8" stem)	\$121.22	\$97.85

Dial Indicators

Features:

- AGD Group 2 specifications
- Graduations: 0.001"
- Supplied with lug back for positioning through 90° increments
- Carbide tipped contact points
- Microfine graduations in black for continuous readings and red for balanced readings



52-520-110-0

Order No.	Range	Reading	Dial Color	List Price	Sale Price
52-520-109-0	0 - 1"	0 - 100	Black	\$89.40	\$80.96
52-520-110-0	0 - 1"	0 - 100	White	\$89.40	\$80.96



Electronic Edge Finders

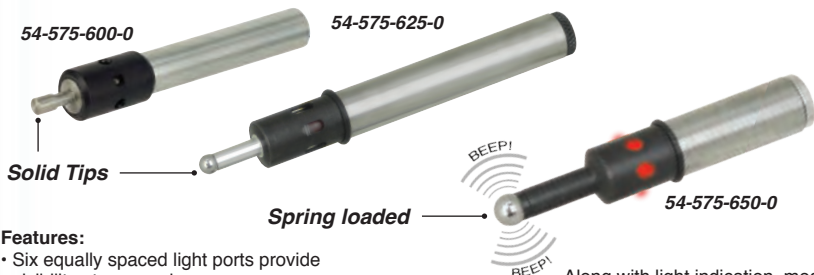

Features:

- Six equally spaced light ports provide visibility at any angle
- Edge finder lights instantly when stylus touches work edge
- Repeatability: 0.0002"
- Works on any conductive metal

Along with light indication, model 54-575-650-0 emits an audible "beep" at time of contact with electrically conductive metal.

Order No.	Stylus	Shank	Audible	List Price	Safe Price
54-575-600-0	0.200"	1/2"	NO	\$45.42	\$41.33
54-575-625-0	0.200"	1/2"	NO	\$156.82	\$142.71
54-575-650-0	0.400"	3/4"	YES	\$156.82	\$142.70

Z-CHECK 65 PLUS+ Z-Axis Tool Setter



Features:

- Supplied with zero reference setting block
- IP65 protected against fluid and dust
- 4 magnets embedded into base
- 2" default setting height
- Steel contact surface with 0.0002" flatness
- Resolution: 0.00005"/0.001mm
- Repeatability: 0.00015"/0.004mm
- Accuracy: 0.0001"/0.003mm
- Includes a rugged, aluminum fitted case

Display lights when ZERO reference is reached.



Order No. 54-188-200-0

Sale \$126.44

List Price \$138.95

mini-MAG Protractor

The mini-MAG Protractor provides instant 360° digital inclination display of any angle.

Features:

- Accuracy: $\pm 0.2^\circ$
- Resolution: 0.05°
- Repeatability: 0.05°
- Measuring range: 360°
- Embedded magnets
- Display automatically inverts
- Dimensions: 2.375" x 1.375" x 2.375"
- Hold feature
- Battery Life: up to 250 hrs.



Display inverts for easy reading!



Order No. 54-422-450-1

Sale \$113.30

List Price \$127.05

1-2-3 & 2-4-6 Blocks

Useful in layout, inspection and grinding work.

Features:

- 23 holes for easy clamping
- Sold in pairs
- Hardened 56 - 60 HRC
- 1-2-3 blocks have 5 threaded holes, 3/8" - 16
- 2-4-6 blocks have 5 threaded holes, 5/8" - 11



52-439-246-0

Order No.	Description	Accuracy	List Price	Sale Price
52-439-031-0	1-2-3 Blocks	± 0.0002"/1"	\$44.99	\$35.99
52-439-246-0	2-4-6 Blocks	± 0.0003"/1"	\$195.99	\$156.79

Parallel Set

10 matched pairs.

Features:

- 2 each of 1/2", 5/8", 3/4", 7/8", 1", 1-1/8", 1-1/4", 1-3/8", 1-1/2" & 1-5/8" heights
- Absolute heights are nominal
- Hardness: 50 HRC, 6" length and 1/8" thickness
- Parallelism: ± 0.0008"
- Paired in height: ± 0.001"



Order No. 52-437-000-0

Sale \$265.³³

List Price \$301.09

Toolmaker's Vise

Toolmaker's Vise makes precision holding possible for inspection, precision jig boring, milling and grinding.



Features:

- Maximum opening: 2.48"
- Dimensions: 6.1" x 1.9" x 2.0"
- Features solid base and front jaw construction
- Parallelism and squareness accuracy: 0.0004"
- Clamping slots on the bottom of the base allow for easily affixing to angle plates, vises, etc.

Order No. 52-466-000-1

Sale \$200.⁸⁵

List Price \$237.93

Prices & Specifications are subject to change without notice.

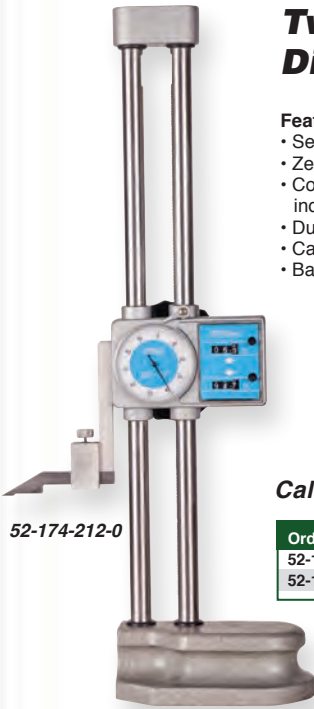

52-174-212-0

Twin Beam Dial Height Gages

Features:

- Separate digit counters register both upward & downward travel
- Zero setting can be obtained throughout the gage's range
- Coarse readings in 0.100" graduations: fine readings taken on indicator are 0.001"
- Dual chrome plated beams
- Carbide-tipped scriber
- Base is ground & lapped for maximum flatness

Calibration certificates available for all sizes.

Order No.	Range	Accuracy	List Price	Sale Price
52-174-212-0	12"	± 0.0015"	\$356.30	\$323.42
52-174-224-0	24"	± 0.002"	\$593.88	\$540.43



54-174-212-3

Twin Beam Electronic Height Gages

Features:

- Range: 12"/300mm
- Accuracy: ± 0.0016"/0.04mm
- Updated electronic and mechanical design with offset scriber offers better accuracy and movement of carriage
- Base is ground and lapped for maximum flatness
- Handwheel provides course and fine movement
- Carbide tipped scriber
- Functions include preset, in/mm conversion and ABS/INC for direct or comparative measuring

Calibration certificates available for all sizes.

Order No.	Range	Accuracy	List Price	Sale Price
54-174-212-3	12"/300mm	± 0.0016"/0.04mm	\$593.88	\$540.43
54-174-224-3	24"/600mm	± 0.002"/0.05mm	\$831.32	\$749.00

Z-HEIGHT**Electronic Height Gages***With handwheel and fine adjust.***Features:**

- Base design has a more comfortable grip and is finely ground and lapped for smooth movement on surface plates
- Fine adjust feature allows precise adjustment to required settings
- Preset feature allows setting pre-determined or reference measurements
- Indicator holding bar included
- Resolution 0.0005"/0.01mm
- Large, high contrast LCD display
- Coarse adjustment hand wheel
- Carriage locking lever
- Carbide tipped scriber



54-175-024-0

Calibration certificates available for all sizes.

Order No.	Range	Accuracy	List Price	Sale Price
54-175-012-0	12"/300mm	± 0.0015"/0.04mm	\$649.90	\$584.91
54-175-018-0	18"/450mm	± 0.002"/0.05mm	\$773.52	\$696.17
54-175-024-0	24"/600mm	± 0.002"/0.05mm	\$870.69	\$792.33

**Single Beam
Electronic Height Gages****Features:**

- Large base is lapped for easy movement
- Resolution: 0.0005"/.01mm
- Large easy to read LCD
- Presettable display
- Carbide tipped scriber

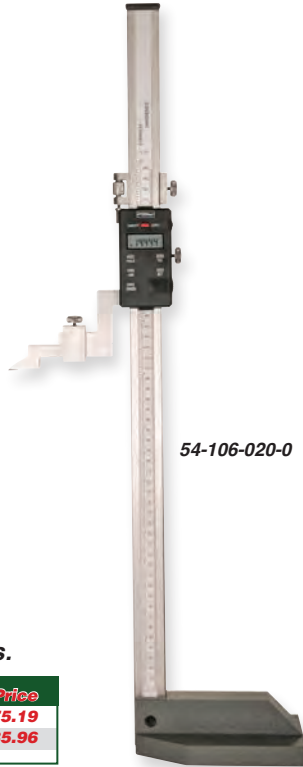

54-106-020-0

Calibration certificates available for all sizes.

Order No.	Range	Accuracy	List Price	Sale Price
54-106-020-0	20"/500mm	± 0.0025"	\$527.99	\$475.19
54-106-040-0	40"/1000mm	± 0.0035"	\$2,428.84	\$2,185.96

Fowler Sylvac Hi_Cal V2 Electronic Height Gages

For your finer, more delicate parts.

Features:

- Bluetooth for quick, easy recorded measurements
- Extra low measuring force, from 0.2N
- Measure internal and external diameters, centerlines, heights, widths, depths and MIN/MAX/TIR capability
- Excellent repeatability thanks to the motorized carriage
- High reliability
- Bluetooth, USB and RS232 data outputs
- Battery life: 40 hours rechargeable during operation
- Touch sensitive probe speed for easy operation
- Base with small footprint
- Includes: protective cover, charging set, ruby ball probe Ø3mm, setting gage and calibration certificate

FREE 1mm Ball Probe
with 6"/150mm and 12"/300mm Hi_Cal Purchase!

NOW

available with ISO Cert

Contact the Fowler Sales Department 1-800-788-2353



54-931-150-BT

Full Probe Set



54-930-215-0



Order No.	Range	Accuracy	List Price	Sale Price
54-931-150-BT	6"/150mm	0.00013"/0.0034mm	\$6,400.27	\$5,888.25
54-931-150-BT-C	6"/150mm with ISO/A2LA Certification			\$6,087.25
54-931-300-BT	12"/300mm	0.00016"/0.0042mm	\$6,986.14	\$6,427.25
54-931-300-BT-C	12"/300mm with ISO/A2LA Certification			\$6,626.25
54-931-450-BT	17.5"/450mm	0.00020"/0.005mm	\$7,952.37	\$7,316.18
54-931-450-BT-C	17.5"/450mm with ISO/A2LA Certification			\$7,515.18
Accessories				
54-930-215-0	Full Probe Set		\$1,864.26	\$1,677.84
54-930-217-0	Basic Probe Set		\$1,056.70	\$951.03



54-931-300-BT



54-931-450-BT



54-930-217-0

FREE
Basic Probe Set

with 54-931-450-BT Hi_Cal Purchase
\$1,056.70 Value!



Fowler Trimos V3, V4, V5 & V7 Electronic Height Gages

The Fowler Trimos V3, V4, V5 & V7 vertical measuring instruments have been developed for the most difficult shop floor environments. Manufactured in Switzerland, they guarantee precise and repeatable measurements with superior ease of use.

Features:

- Industry leading software simplifies measuring tasks
- Electronically adjustable measuring force 0.75/1.5 (N)
- Lithium-ion rechargeable batteries last up to 40 hours
- All adjustments possible without tools
- Cast iron base for optimal stability and rigidity
- Bluetooth transmitter available
- Dual probe holders (V4 - V7)
- Carriage displacement: Manual for V3 and V4 models
V5 includes selectable manual or motorized carriage displacement
- **V7 features 2D measuring, parts programming, statistics, tablet style display, and higher resolution of 0.0001"/0.0001mm**
- Measures heights, diameters, perpendicularity, centerlines, Min/Max/Delta
- Resolution: 0.00005"/0.001mm
- **V3 - V5:** Repeatability (2s): 0.00008"/0.002mm (Ø 0.00016"/0.004mm)
- **V7:** Repeatability (2s): 0.00002"/0.0005mm (Ø 0.00004"/0.001mm)



All models Include:

- Charging unit
- Measuring probe with ruby ball Ø4mm
- Probe holder elbow Ø 8mm
- Setting gage
- User's manual and test certificate

V3		54-192-340-0	54-192-370-0
Measuring Range	16"/407mm		28"/711mm
Range with Probe inverted	20"/508mm		20"/508mm
Max. Permissible Errors	0.00028"/0.007mm		0.00032"/0.008mm
Frontal Squareness Deviation	0.0004"/0.010mm		0.0006"/0.015mm
Air Cushion		NO	
V4		54-191-440-0	54-191-470-0
Measuring Range	16"/407mm		28"/711mm
Range with Probe inverted	28.3"/719mm		40.2"/1023mm
Max. Permissible Errors	0.0002"/0.005mm		0.00028"/0.007mm
Frontal Squareness Deviation	0.0004"/0.010mm		0.0006"/0.015mm
Air Cushion		YES	
V5		54-199-540-0	54-199-570-0
Measuring Range	16"/407mm		28"/711mm
Range with Probe inverted	28.3"/719mm		40.2"/1023mm
Max. Permissible Errors (µm)		2.5 + L(mm)/300	
Frontal Squareness Deviation	0.0002"/0.005mm		0.00032"/0.008mm
Air Cushion		YES	
V7		54-199-770-0	
Measuring Range	28"/711mm		
Range with Probe inverted	40"/1023mm		
Max. Permissible Errors (µm)		2.5 + L(mm)/400	
Frontal Squareness Deviation	0.00032"/0.008mm		
Air Cushion	YES		



EXTREMELY Easy to Use!

54-192-340-0



54-191-440-0



54-199-570-0



54-199-770-0

Measures ID/OD, centerlines, heights, widths, depths, min/max/delta, slots, grooves and more!

**Certify Any Height Gage Below
For Only \$199.00**

Valid only for Tool-A-Thon 23.3

**Height Gages available up to 40", 60", 80" upon request*

Order No.	Description	Range	List Price	Sale Price
54-192-340-0	V3 Height Gage	16"/407mm	\$5,262.11	\$5,025.31
54-192-370-0	V3 Height Gage	28"/711mm	\$5,801.68	\$5,540.61
54-191-440-0	V4 Height Gage	16"/407mm	\$6,931.40	\$6,619.48
54-191-470-0	V4 Height Gage	28"/711mm	\$8,063.41	\$7,700.55
54-199-540-0	V5 Height Gage	16"/407mm	\$7,639.31	\$7,295.55
54-199-570-0	V5 Height Gage	28"/711mm	\$9,052.87	\$8,645.49
54-199-770-0	V7 Height Gage	28"/711mm	\$12,409.00	\$11,850.59
Probe Sets				
54-199-105-0	4mm Probe Set, 21 piece		\$2,024.45	\$1,923.23
54-199-106-0	8mm Probe Set, 16 piece		\$1,510.68	\$1,435.15
54-199-107-0	8mm Basic Probe Set, 7 piece		\$536.35	\$509.53
Accessories				
45-300-002-0	ISO Certification		\$379.00	\$199.00
54-199-400-0	12"/300mm Holder - for 8mm probes		\$1,133.27	\$1,076.60
54-199-022-BT	Bluetooth transmitter (Not available for V3 models)		\$750.87	\$683.29
54-777-120-0	Vmux software - for connecting multiple units to one PC		\$522.85	\$475.79

Prices & Specifications are subject to change without notice.



Headquarters

780 Dedham Street • Canton • Massachusetts 02021
(800) 788-2353 • (617) 332-4137 fax
sales@fowlerprecision.com • www.fowlerprecision.com

Distribution Center & Showroom

28010 Industry Drive
Valencia, California 91355
(415) 633-5354

Find us on social media

